

606907

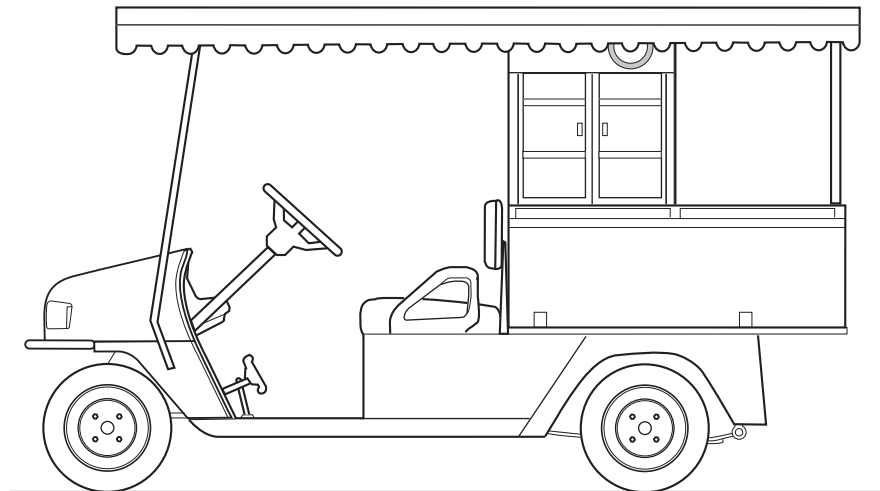

A Textron Company

OWNER'S MANUAL AND SERVICE GUIDE



GASOLINE POWERED REFRESHMENT VEHICLE

ISSUED OCTOBER 2007 REVISED FEBRUARY 2010

SAFETY

For any questions on material contained in this manual, contact an authorized representative for clarification.

Read and understand all labels located on the vehicle. Always replace any damaged or missing labels.

On steep hills it is possible for vehicles to coast at greater than normal speeds encountered on a flat surface. To prevent loss of vehicle control and possible serious injury, speeds should be limited to no more than the maximum speed on level ground. See GENERAL SPECIFICATIONS. Limit speed by applying the service brake.

Catastrophic damage to the drivetrain components due to excessive speed may result from driving the vehicle above specified speed. Damage caused by excessive speed may cause a loss of vehicle control, is costly, is considered abuse and will not be covered under warranty.

For towing/transporting vehicle, refer to "TRANSPORTING VEHICLE".

Signs similar to the ones illustrated should be used to warn of situations that could result in an unsafe condition.

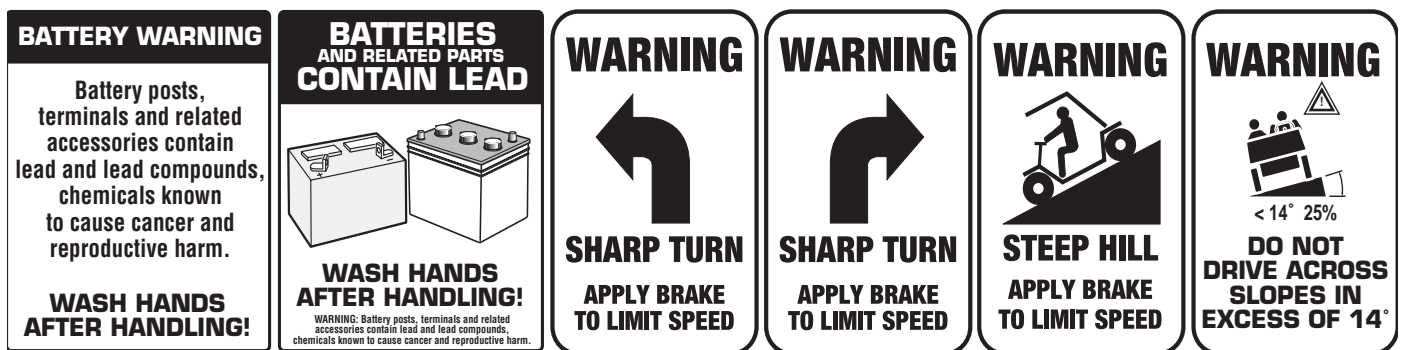

Be sure that this manual remains as part of the permanent service record should the vehicle be sold. Throughout this guide **NOTE**, **CAUTION** and **WARNING** will be used.

Observe these **NOTES**, **CAUTIONS** and **WARNINGS**; be aware that servicing a vehicle requires mechanical skill and a regard for conditions that could be hazardous. Improper service or repair may damage the vehicle or render it unsafe.

NOTE

A **NOTE** indicates a condition that should be observed.



CAUTION

A **CAUTION** indicates a condition that may result in damage to the vehicle.



WARNING

A **WARNING** indicates a hazardous condition that could result in severe injury or death.



WARNING

Engine exhaust from this product contains chemicals known, in certain quantities, to cause cancer, birth defects, or other reproductive harm.

NOTE

The exhaust emissions of this vehicles' engine complies with regulations set forth by the Environmental Protection Agency (EPA) of the United States of America (USA) at time of manufacture. Significant fines could result from modifications or tampering with the engine, fuel, ignition or air intake systems.



WARNING

Battery posts, terminals and related accessories contain lead and lead compounds. Wash hands after handling.

NOTE

This spark ignition system meets all requirements of the Canadian Interference-Causing Equipment Regulations.

Ce système d'allumage par étincelle de véhicule respecte toutes les exigences du Règlement sur le matériel brouilleur du Canada.

(NOTES, CAUTIONS AND WARNINGS CONTINUED ON INSIDE OF BACK COVER)

OWNER'S MANUAL AND SERVICE GUIDE

GASOLINE POWERED REFRESHMENT VEHICLE

REFRESHER[®] 1200
REFRESHER[®] 1200 CARB

Starting Model Year 2008

The E-Z-GO Division of Textron Inc. reserves the right to incorporate engineering and design changes to products in this Manual, without obligation to include these changes on units leased/sold previously.

The information contained in this Manual may be revised periodically by the E-Z-GO Division, and therefore is subject to change without notice.

The E-Z-GO Division **DISCLAIMS LIABILITY FOR ERRORS IN THIS MANUAL**, and the E-Z-GO Division **SPECIFICALLY DISCLAIMS LIABILITY FOR INCIDENTAL AND CONSEQUENTIAL DAMAGES** resulting from the use of the information and materials in this Manual.

These are the original instructions as defined by 2006/42/EC

TO CONTACT US

NORTH AMERICA:

TECHNICAL ASSISTANCE & WARRANTY PHONE: 1-800-774-3946, FAX: 1-800-448-8124

SERVICE PARTS PHONE: 1-888-GET-EZGO (1-888-438-3946), FAX: 1-800-752-6175

INTERNATIONAL: PHONE: 001-706-798-4311, FAX: 001-706-771-4609

E-Z-GO DIVISION OF TEXTRON, INC., 1451 MARVIN GRIFFIN ROAD, AUGUSTA, GEORGIA USA 30906-3852

GENERAL INFORMATION

This vehicle has been designed and manufactured in the United States of America (USA) as a 'World Vehicle'. The Standards and Specifications listed in the following text originate in the USA unless otherwise indicated.

The use of non Original Equipment Manufacturer (OEM) approved parts may void the warranty.

Overfilling battery may void the warranty.

Tampering with or adjusting the governor to permit vehicle to operate at above factory specifications will void the vehicle warranty.

When servicing engines, all adjustments and replacement components must be per original vehicle specifications in order to maintain the United States of America Federal and State emission certification applicable at the time of manufacture.

BATTERY PROLONGED STORAGE

All batteries will self discharge over time. The rate of self discharge varies depending on the ambient temperature and the age and condition of the batteries.

A fully charged battery will not freeze in winter temperatures unless the temperature falls below -75 F (-60 C).

TABLE OF CONTENTS

SAFETY	INSIDE COVERS
GENERAL INFORMATION	II
SAFETY INFORMATION	VII
REFRESHMENT UNIT	1
MOUNT VENDING UNIT TO REFRESHMENT VEHICLE	1
FRONT STRUT INSTALLATION	1
WINDSHIELD AND MIRROR INSTALLATION	1
<i>Fig. 1 Mounting the Refreshment Unit</i>	2
CANOPY FRAME INSTALLATION	2
CANOPY INSTALLATION	2
<i>Fig. 2 Front Strut, Windshield and Mirror Installation</i>	3
DRAIN VALVE INSTALLATION	3
REFRESHMENT UNIT REMOVAL	3
REFRESHMENT UNIT OPERATION, MAINTENANCE AND CLEANING	3
Operation	3
<i>Fig. 3 Canopy Installation</i>	4
Cleaning	5
<i>Fig. 4 Emptying Water from Bins</i>	5
Maintenance	5
REFRESHMENT UNIT REPLACEMENT PARTS	5
BEFORE INITIAL USE	5
<i>Fig. 5 Initial Service Chart</i>	6
CONTROLS AND INDICATORS	6
KEY/LIGHT SWITCH	6
<i>Fig. 6 Key/Light Switch, Low Oil Pressure Light and Fuel Gauge</i>	6
DIRECTION SELECTOR	6
CHOKE	6
<i>Fig. 7 Direction Selector</i>	6
FUEL GAUGE	6
<i>Fig. 8 Choke</i>	7
LOW OIL PRESSURE INDICATOR LIGHT	7
ACCELERATOR PEDAL	7
<i>Fig. 9 Accelerator and Brake Controls</i>	7
COMBINATION SERVICE AND PARK BRAKE PEDAL	7
FRONT DISC BRAKES (OPTIONAL)	7
HORN	8
<i>Fig. 10 Horn Button</i>	8
OPERATING THE VEHICLE	8
RUN-IN	8
<i>Fig. 11 Check Oil Level on Dipstick</i>	9
COLD STARTING	9
STARTING AND DRIVING	9
STARTING THE VEHICLE ON A HILL	9
COASTING	10
FUEL	10
<i>Fig. 12 Fueling</i>	10
BATTERY	10
LABELS AND PICTOGRAMS	11
SUN TOP AND WINDSHIELD	11
12 VOLT POWER OUTLET	11
<i>Fig. 13 12 Volt Power Outlet</i>	11
TOWING A TRAILER	11
VEHICLE CLEANING AND CARE	11
VEHICLE CLEANING	11

TABLE OF CONTENTS

REPAIR	12
LIFTING THE VEHICLE	13
<i>Fig. 14 Lifting the Vehicle</i>	13
WHEELS AND TIRES	13
Tire Repair	13
Wheel Installation	14
<i>Fig. 15 Wheel Installation</i>	14
LIGHT BULB REPLACEMENT	14
<i>Fig. 16 Headlight and Turn Signal Bulb Replacement</i>	14
FUSE REPLACEMENT	14
<i>Fig. 17 Tail and Brake Light Bulb Replacement</i>	15
VEHICLE WITH A DISCHARGED BATTERY	15
TRANSPORTING VEHICLE	15
TOWING	15
NEUTRAL LOCK	15
<i>Fig. 18 Neutral Lock</i>	15
HAULING	16
SERVICE AND MAINTENANCE	16
SERIAL NUMBER LABEL LOCATION	17
<i>Fig. 19 Serial Number Plate Location</i>	17
PERIODIC SERVICE SCHEDULE	18
<i>Fig. 20 Periodic Service Schedule</i>	18
TIRE INSPECTION	19
FOUR CYCLE ENGINE	20
ENGINE SPECIFICATIONS	20
ENGINE DESCRIPTION	20
CHECKING OIL LEVEL	20
<i>Fig. 21 Clean Entire Dipstick</i>	20
<i>Fig. 22 Check Oil Level on Dipstick</i>	20
CHANGING THE OIL	20
<i>Fig. 23 Oil Viscosity Chart</i>	21
<i>Fig. 24 Cleaning Top of Engine</i>	21
<i>Fig. 25 Remove Oil Filter</i>	21
<i>Fig. 26 Inspect Oil Filter</i>	21
<i>Fig. 27 Oil Drain Plug</i>	22
<i>Fig. 28 Add Engine Oil</i>	22
STARTER/GENERATOR BELT TENSION	22
<i>Fig. 29 Check Belt Tension with Gauge</i>	23
<i>Fig. 30 Check Belt Tension Manually</i>	23
<i>Fig. 31 Adjust Belt Tension</i>	23
ADJUSTING THE BELT	23
BATTERY CLEANING	23
<i>Fig. 32 Preparing Acid Neutralizing Solution</i>	24
<i>Fig. 33 Typical Brake Performance Test</i>	24
BRAKES	24
PERIODIC BRAKE TEST FOR MECHANICAL BRAKES	24
AIR INTAKE AND COOLING FINS	25
<i>Fig. 34 Cleaning Cooling System with Air</i>	25
REAR AXLE	25
CHECKING THE LUBRICANT LEVEL	25
AIR CLEANER INSPECTION AND REPLACEMENT	25
<i>Fig. 35 Add, Check and Drain Rear Axle Lubricant</i>	26
<i>Fig. 36 Air Cleaner</i>	26
LUBRICATION	26
<i>Fig. 37 Lubrication Points</i>	27
SPARK PLUGS	27
<i>Fig. 38 Gapping the Spark Plug</i>	27
DIRECTION SELECTOR	27

TABLE OF CONTENTS

PROLONGED STORAGE	27
HARDWARE	28
<i>Fig. 39 Torque Specifications and Bolt Grades</i>	28
CAPACITIES AND REPLACEMENT PARTS	29
<i>Fig. 40 Capacities and Replacement Parts</i>	29
GENERAL SPECIFICATIONS.....	31
Refresher 1200	32
<i>Fig. 41 Vehicle Dimensions</i>	33
<i>Fig. 42 Vehicle Dimensions, Incline Specifications and Turning Clearance Diamete</i>	34
VEHICLE WARRANTIES	APPENDIX A
VEHICLE WARRANTIES CALIFORNIA	A-3
VEHICLE WARRANTIES FEDERAL	A-5
DECLARATION OF CONFORMITY	APPENDIX B
LABELS AND PICTOGRAMS	APPENDIX C

SAFETY INFORMATION

This manual has been designed to assist in maintaining the vehicle in accordance with procedures developed by the manufacturer. Adherence to these procedures and troubleshooting tips will ensure the best possible service from the product. To reduce the chance of personal injury or property damage, the following must be carefully observed:



CAUTION

Certain replacement parts can be used independently and/or in combination with other accessories to modify an E-Z-GO-manufactured vehicle to permit the vehicle to operate at or in excess of 20mph. When an E-Z-GO-manufactured vehicle is modified in any way by the Distributor, Dealer or customer to operate at or in excess of 20mph, UNDER FEDERAL LAW the modified product will be a Low Speed Vehicle (LSV) subject to the strictures and requirements of Federal Motor Vehicle Safety Standard 571.500. In these instances, pursuant to Federal law the Distributor or Dealer MUST equip the product with headlights, rear lights, turn signals, seat belts, top, horn and all other modifications for LSV's mandated in FMVSS 571.500, and affix a Vehicle Identification Number to the product in accordance with the requirements of FMVSS 571.565. Pursuant to FMVSS 571.500, and in accordance with the State laws applicable in the places of sale and use of the product, the Distributor, Dealer or customer modifying the vehicle also will be the Final Vehicle Manufacturer for the LSV, and required to title or register the vehicle as mandated by State law.

E-Z-GO will NOT approve Distributor, Dealer or customer modifications converting E-Z-GO products into LSV's.

The Company, in addition, recommends that all E-Z-GO products sold as personal transportation vehicles BE OPERATED ONLY BY PERSONS WITH VALID DRIVERS LICENSES, AND IN ACCORDANCE WITH APPLICABLE STATE REQUIREMENTS. This restriction is important to the SAFE USE AND OPERATION of the product. On behalf of E-Z-

GO, I am directing that E-Z-GO Branch personnel, Distributors and Dealers advise all customers to adhere to this SAFETY RESTRICTION, in connection with the use of all products, new and used, the Distributor or Dealer has reason to believe may be operated in personal transportation applications.

Information on FMVSS 571.500 can be obtained at Title 49 of the Code of Federal Regulations, section 571.500, or through the Internet at the website for the U.S. Department of Transportation - at Dockets and Regulation, then to Title 49 of the Code of Federal Regulations (Transportation).

GENERAL

Many vehicles are used for a variety of tasks beyond the original intended use of the vehicle; therefore, it is impossible to anticipate and warn against every possible combination of circumstances that may occur. No warnings can take the place of good common sense and prudent driving practices.

Good common sense and prudent driving practices do more to prevent accidents and injury than all of the warnings and instructions combined. The manufacturer strongly suggests that all users and maintenance personnel read this entire manual paying particular attention to the CAUTIONS and WARNINGS contained therein.

If you have any questions regarding this vehicle, contact your closest representative or write to the address on the back cover of this publication, Attention: Product Service Department.

The manufacturer reserves the right to make design changes without obligation to make these changes on units previously sold and the information contained in this manual is subject to change without notice.

The manufacturer is not liable for errors in this manual or for incidental or consequential damages that result from the use of the material in this manual.

This vehicle conforms to the current applicable standard(s) for safety and performance requirements.

These vehicles are designed and manufactured for off-road use. They do not conform to Federal Motor Vehicle Safety Standards of the United States of America (USA) and are not equipped for operation on public streets. Some communities may permit these vehicles to be operated on their streets on a limited basis and in accordance with local ordinances.

SAFETY INFORMATION

Refer to GENERAL SPECIFICATIONS for vehicle seating capacity.

Never modify the vehicle in any way that will alter the weight distribution of the vehicle, decrease its stability or increase the speed beyond the factory specification. Such modifications can cause serious personal injury or death. Modifications that increase the speed and/or weight of the vehicle will extend the stopping distance and may reduce the stability of the vehicle. Do not make any such modifications or changes. The manufacturer prohibits and disclaims responsibility for any such modifications or any other alteration which would adversely affect the safety of the vehicle.

Vehicles that are capable of higher speeds must limit their speed to no more than the speed of other vehicles when used in a golf course environment. Additionally, speed should be further moderated by the environmental conditions, terrain and common sense.

Operation of the vehicle is limited to persons above the height of 59 in. (150 cm).

GENERAL OPERATION

Always:

- Use the vehicle in a responsible manner and maintain the vehicle in safe operating condition.
- Read and observe all warnings and operation instruction labels affixed to the vehicle.
- Follow all safety rules established in the area where the vehicle is being operated.
- Leave the vehicle when there is a risk of lightning.
- Reduce speed to compensate for poor terrain or conditions.
- Apply service brake to control speed on steep grades.
- Maintain adequate distance between vehicles.
- Reduce speed in wet areas.
- Use extreme caution when approaching sharp or blind turns.
- Use extreme caution when driving over loose terrain.
- Use extreme caution in areas where pedestrians are present.

MAINTENANCE

Always:

- Maintain the vehicle in accordance with the manufacturer's periodic service schedule.
- Ensure that repairs are performed by those that are trained and qualified to do so.
- Follow the manufacturer's maintenance procedures for the vehicle. Be sure to disable the vehicle before performing any maintenance. Disabling includes removing the key from the key switch and removal of a battery wire.
- Insulate any tools used within the battery area in order to prevent sparks or battery explosion caused by shorting the battery terminals or associated wiring. Remove the battery or cover exposed terminals with an insulating material.
- Use specified replacement parts. Never use replacement parts of lesser quality.
- Use recommended tools.
- Determine that tools and procedures not specifically recommended by the manufacturer will not compromise the safety of personnel nor jeopardize the safe operation of the vehicle.

SAFETY INFORMATION

- Support the vehicle using wheel chocks and jack stands. Never get under a vehicle that is supported by a jack. Lift the vehicle in accordance with the manufacturer's instructions.
- Empty the fuel tank or plug fuel hoses to prevent fuel leakage.
- Maintain the vehicle in an area away from exposed flame or persons who are smoking.
- Be aware that a vehicle that is not performing as designed is a potential hazard and must not be operated.
- Test drive the vehicle after any repairs or maintenance. All tests must be conducted in a safe area that is free of both vehicular and pedestrian traffic.
- Replace damaged or missing warning, caution or information labels.
- Keep complete records of the maintenance history of the vehicle.

The manufacturer cannot anticipate all situations, therefore people attempting to maintain or repair the vehicle must have the skill and experience to recognize and protect themselves from potential situations that could result in severe personal injury or death and damage to the vehicle. Use extreme caution and, if unsure as to the potential for injury, refer the repair or maintenance to a qualified mechanic.

VENTILATION

Always store gasoline vehicles in a well ventilated area. Ventilation prevents gasoline fumes from accumulating.

Never fuel a vehicle in an area that is subject to flame or spark. Pay particular attention to natural gas or propane water heaters and furnaces.

Never work around or operate a vehicle in an environment that does not ventilate exhaust gases from the area. Carbon monoxide is a dangerous gas that can cause unconsciousness and is potentially lethal.

SAFETY INFORMATION

NOTES:

A large grid of graph paper for taking notes, consisting of 20 columns and 30 rows of small squares.

SAFETY INFORMATION

The following text is provided as recommended by part II of ANSI/ITSDF B56.8 - 2005. The manufacturer strongly endorses the contents of this specification.

6 GENERAL SAFETY PRACTICES

6.1 Introduction

6.1.1 Like other machines, carriers can cause injury if improperly used or maintained. Part II contains broad safety practices applicable to carrier operation. Before operation, the user shall establish such additional specific safety practices as may reasonably be required for safe operation.

6.1.2 Premise review — The user shall periodically review their premises, and as conditions warrant, identify areas where carriers should not be operated and to identify possible hazards such as the following examples:

- a) Steep Grade — In areas where steep grades exist, carrier operation should be restricted to the designated vehicle's pathways where possible, and shall be identified with a suitable warning giving the following information: "Warning, steep grade."
- b) Wet Areas — Wet areas could cause a carrier to lose traction and could affect steering, stability and braking.
- c) Sharp Turns, Blind Spots, Bridge Approaches — Sharp turns, blind spots, bridge approaches, and other potentially hazardous areas shall be identified with a suitable warning to the operator of the nature of the hazard and stating the proper precautions to be taken to avoid the hazard.
- d) Loose Terrain — Loose terrain could cause a carrier to lose traction and could affect steering, stability, and braking.

6.2 Operation

Experience has shown that carriers, which comply with the provisions, stated in paragraph 9.3.9 are stable when properly operated and when operated in accordance with specific safety rules and practices established to meet actual operating terrain and conditions. However, improper operation, faulty maintenance, or poor housekeeping may contribute to a condition of instability and defeat the purpose of the standard. Some of the conditions which may affect stability are failure of the user to follow safety practices; also, ground and floor conditions, grade, speed, loading, the operation of the carrier with improper loads, battery weight, dynamic and static forces, and the judgment exercised by the carrier operator.

- a) The user shall train carrier operators to adhere strictly to the operating instructions stated in this Standard.
- b) The user shall survey specific operating conditions and environment, and establish and train carrier operators to comply with additional, specific safety practices.

6.3 Nameplates, Markings, Capacity, and Modifications

6.3.1 The user shall maintain in a legible condition all nameplates, warnings, and instructions, which are supplied by the manufacturer.

6.3.2 Except as provided in 6.3.4, no modifications or alterations to a carrier, which may affect the capacity, stability, or safe operation of the carrier, shall be made without the prior written approval of the original carrier manufacturer or a successor thereof. When the carrier manufacturer or its successor approves a modification or alteration, appropriate changes shall be made to capacity plates, decals, tags, and operation and maintenance manuals

6.3.3 As required under paragraphs 6.3.1 or 6.3.2, the manufacturer shall be contacted to secure new nameplates, warnings, or instructions, which shall then be affixed in their proper place on the carrier.

6.3.4 In the event that the carrier manufacturer is no longer in business and there is no successor in interest to the business, the user may arrange for a modification or alteration to a carrier, provided however, the controlling party shall:

- (1) Arrange for the modification or alteration to be designed, tested, and implemented by an engineer(s) expert in carrier(s) and their safety;

SAFETY INFORMATION

- (2) Maintain a permanent record of the design, test(s), and implementation of the modification or alteration;
- (3) Make appropriate changes to the capacity plate(s), decals, tags, and operation and maintenance manuals;
- (4) Affix a permanent and readily visible label on the carrier stating the manner in which the carrier has been modified or altered together with the date of the modification or alteration, and the name of the organization that accomplished the tasks.

6.4 Fuel Handling and Storage

6.4.1 The user shall supervise the storage and handling of liquid fuels (when used) to be certain that it is in accordance with ANSI/NFPA 505 and ANSI/NFPA 30 or as required by local ordinance.

6.4.2 Storage and handling of liquefied petroleum gas fuels shall be in accordance with ANSI/NFPA 505 and ANSI/NFPA 58 or as required by local ordinance. If such storage or handling is not in compliance with these standards, the user shall prevent the carrier from being used until such storage and handling is in compliance with these standards.

6.4.3 Prevent fire and explosion caused by static electric discharge. Use only non-metal, portable fuel containers approved by the Underwriter's Laboratory (U.L.) or the American Society for Testing & Materials (ASTM). If using a funnel, make sure it is plastic and has no screen or filter.

Static electric discharge can ignite gasoline vapors in an ungrounded fuel container. Remove the fuel container from the bed of a carrier or the trunk of a car and place on the ground away from the carrier before filling. Keep nozzle in contact with container opening while filling. When practical, remove equipment from trailers or truck beds and re-fuel them on the ground. If this is not possible, use a portable, plastic fuel container to refuel equipment on a truck bed or trailer.

6.5 Changing and Charging Storage Batteries for Electric Personnel and Burden Carriers

6.5.1 The user shall require battery changing and charging facilities and procedures to be in accordance with ANSI/NFPA 505 or as required by local ordinance.

6.5.2 The user shall periodically inspect facilities and review procedures to be certain that ANSI/NFPA 505 or as required by local ordinance, are strictly complied with, and shall familiarize carrier operators with it.

6.5.3 Maintenance and storage areas for carriers shall be properly ventilated to avoid fire hazards in accordance with applicable fire codes and ordinances.

Ventilation for internal combustion engine powered carriers shall be provided to remove flammable vapors (gases), fumes and other flammable materials. Consult applicable fire codes for specific levels of ventilation.

Ventilation for electric powered carriers shall be provided to remove the accumulation of flammable hydrogen gas emitted during the battery charging process. The amount of hydrogen gas emitted depends upon a number of factors such as the condition of the batteries, the output rate of the battery charger and the amount of time the batteries are on charge. Because of the highly volatile nature of hydrogen gas and its propensity to accumulate in pockets, a minimum number of air changes per hour is required during charging.

Consult applicable fire and safety codes for the specific ventilation levels required as well as the use of explosion proof electrical apparatus. SAE J1718 can be followed to check for hydrogen gas levels.

6.6 Hazardous Locations

6.6.1 The user shall determine the hazard classification of the particular atmosphere or location in which the carrier is to be used in accordance with ANSI/NFPA 505.

6.6.2 The user shall permit in hazardous areas only those carriers approved and of the type required by ANSI/NFPA 505.

6.7 Lighting for Operating Area

The user, in accordance with his responsibility to survey the environment and operating conditions, shall determine if

SAFETY INFORMATION

the carrier requires lights and, if so, shall equip the carrier with appropriate lights.

6.8 Control of Noxious Gases and Fumes

When equipment powered by internal combustion engines is used in enclosed areas, the atmosphere shall be maintained within limits specified in the American Conference of Governmental Industrial Hygienists publication, "Threshold Limit Values for Chemical Substances and Physical Agents in the Workroom Environment." This may be accomplished by ventilation maintenance of emission control equipment recommended or provided by the manufacturer of the equipment.

6.9 Warning Device(s)

6.9.1 The user shall make periodic inspections of the carrier to be certain that the sound-producing and/or visual device(s) if so equipped are maintained in good operating condition.

6.9.2 The user shall determine if operating conditions require the carrier to be equipped with additional sound-producing or visual devices or both and be responsible for providing and maintaining such devices, in accordance with the manufacturer's recommendations.

6.10 Safety Interlocks

The user shall make periodic inspections of the carrier to be certain that the safety interlock system, if so equipped, is operating properly.

7 OPERATING SAFETY RULES AND PRACTICES

7.1 Personnel and Burden Carrier Operator Qualifications

Only persons who are trained in the proper operation of the carrier shall be authorized to operate the carrier. Operators shall be qualified as to visual, auditory, physical, and mental ability to safely operate the equipment according to Section 7, all other applicable parts of this Standard and the operators' manual.

7.2 Personnel and Burden Carrier Operators' Training

7.2.1 The user shall conduct an operators' training program.

7.2.2 Successful completion of the operators' training program by the operator shall be required before operation of the carrier. The program shall be presented in its entirety to all-new operators and not condensed for those claiming previous experience.

7.2.3 The user shall include as a minimum in the operators' training program the following.

- a) Instructional material provided by the manufacturer including the operators' manual;
- b) Emphasis on safety of passengers, material loads, carrier operator, and other person(s);
- c) General safety rules contained within this Standard and the additional specific rules determined by the user in accordance with this Standard, and why they were formulated;
- d) Introduction of equipment, control locations of the environment which could affect carrier operation;
- e) Operator competency evaluations.

7.3 Personnel and Burden Carrier Operator Responsibility

7.3.1 General Operator Responsibility

7.3.1.1 Read and follow operators' manual

7.3.1.2 Do not operate carrier under the influence of drugs and alcohol.

SAFETY INFORMATION

7.3.1.3 Safeguard the pedestrians at all times. Do not drive carrier in a manner that would endanger other persons.

7.3.1.4 Riding on the carrier by persons other than the operator is authorized only on personnel seat(s) provided by the manufacturer. All parts of each person's body shall remain within the plan view outline of the carrier.

7.3.1.5 When a carrier is to be left unattended, stop the carrier, apply the parking brake, stop the engine or turn off power, turn off the control or ignition circuit, and remove the key if provided. Additionally, for the electric carriers, the forward and reverse directional controls, should be neutralized if a means is provided. Block the wheels if the carrier is on an incline.

7.3.1.6 A carrier is considered unattended when the operator is 7.6m (25 ft.) or more from the carrier which remains in his view, or whenever the operator leaves the carrier and it is not within his view. When the operator is dismounted and within 7.6m (25 ft.) of the carrier still in his view, he still must have controls neutralized, and the parking brake(s) set to prevent movement.

7.3.1.7 Maintain a safe distance from potential hazards, such as edges of ramps and platforms.

7.3.1.8 Use only approved carriers in hazardous locations, as defined in the appropriate safety standards.

7.3.1.9 Report all accidents to the user.

7.3.1.10 Do not add to, or modify, the carrier.

7.3.1.11 Carriers shall not be parked or left unattended such that they block or obstruct fire aisles, access to stairways, or fire equipment.

7.3.1.12 Only operate carrier while within operator's station.

7.3.2 Traveling

7.3.2.1 Observe all traffic regulations, including authorized speed limits. Under normal traffic conditions keep to the right. Maintain a safe distance, based on speed of travel, from a carrier or vehicle ahead, and keep the carrier under control at all times.

7.3.2.2 Yield the right of way to pedestrians, ambulances, fire trucks, or other carriers or vehicles in emergency situations.

7.3.2.3 Do not pass another carrier or vehicle traveling in the same direction at intersections, blind spots, or at other dangerous locations.

7.3.2.4 Keep a clear view of the path of travel, observe other traffic and personnel, and maintain a safe clearance.

7.3.2.5 Slow down or stop, as conditions dictate, and activate the sound-producing warning device at cross aisles and when visibility is obstructed at other locations.

7.3.2.6 Ascend or descend grades slowly.

7.3.2.7 Avoid turning, if possible, and use caution on grades, ramps, or inclines, normally travel straight up and down.

7.3.2.8 Under all travel conditions the carrier shall be operated at a speed that will permit it to be brought to a stop in a safe manner.

7.3.2.9 Make starts, stops, turns, or direction reversals in a smooth manner so as not to shift the load, endanger passengers, or lose control of the carrier.

7.3.2.10 Do not operate carrier in a dangerous manner.

7.3.2.11 Slow down when approaching, or on, wet or slippery surfaces.

7.3.2.12 Do not drive carrier onto any elevator unless specifically authorized to do so. Approach elevators slowly, and then enter squarely after the elevator car is properly leveled. Once on the elevator, neutralize the controls, shut off power, and set parking brakes. It is advisable that all other personnel leave the elevator before a carrier is allowed to enter or exit.

7.3.2.13 Avoid running over loose objects, potholes, and bumps.

7.3.2.14 Reduce carrier speed to negotiate turns.

7.3.2.15 Avoid any action verbal or physical by an operator or passenger, which could cause the operator to be distracted.

SAFETY INFORMATION

7.3.3 Loading

7.3.3.1 Refer to operators' manual for loading instruction.

7.3.3.2 Handle only stable and safely arranged loads. When handling off-center loads, which cannot be centered, operate with extra caution.

7.3.3.3 Handle only loads within the capacity of each cargo area of the carrier as specified by the manufacturer.

7.3.3.4 Avoid material loads exceeding the physical dimensions of the carrier or as specified by the carrier manufacturer.

7.3.4 Operator Care of Personnel and Burden Carriers

7.3.4.1 Read and follow operators' manual.

7.3.4.2 At the beginning of each shift during which the carrier will be used, the operator shall check the carrier condition and inspect the tires, warning devices, lights, battery(s), speed and directional controllers, brakes, safety interlocks, and steering mechanism. If the carrier is found to be in need of repair, or in any way unsafe, the matter shall be reported immediately to the user and the carrier shall not be operated until it has been restored to safe operating condition.

7.3.4.3 If during operation the carrier becomes unsafe in any way, the matter shall be reported immediately to the user, and the carrier shall not be operated until it has been restored to safe operating condition.

7.3.4.4 Do not make repairs or adjustments unless specifically trained and authorized to do so.

7.3.4.5 Before refueling, the engine shall be stopped and allowed to cool. The operator and passengers shall leave the carrier before refueling.

7.3.4.6 Spillage of hazardous materials shall be contained immediately and addressed via appropriate hazardous materials regulations.

7.3.4.7 Do not operate a carrier with a leak in the fuel system or battery(s). Battery(s) shall be charged and serviced per manufacturer's instructions.

7.3.4.8 Do not use open flames for checking electrolyte level in storage battery(s) or liquid level in fuel tanks.

8 MAINTENANCE PRACTICES

8.1 Introduction

Carriers may become hazardous if maintenance is neglected. Maintenance facilities, trained personnel, and procedures shall be provided. Such facilities may be on or off the premises.

8.2 Maintenance Procedures

Maintenance and inspection of all carriers shall be performed in conformance with the following practices and should follow the manufacturer's recommendations.

- a) A scheduled preventive maintenance, lubrication, and inspection system shall be followed.
- b) Only trained and authorized personnel shall be permitted to maintain, repair, adjust, and inspect carriers.
- c) Before undertaking maintenance or repair follow the manufacturer's recommendations for immobilizing the carrier.
- d) Chock wheels and support carrier, before working underneath it.
- e) Before disconnecting any part of the engine fuel system, be sure the shutoff valve, if so equipped, is closed and follow carrier manufacturer's recommended practice.
- f) Operation to check performance of the carrier shall be conducted in an authorized area where suitable conditions exist, free of vehicular and pedestrian traffic.
- g) Before returning carrier to service, follow the manufacturer's instructions and recommended procedure.
- h) Avoid fire hazards and have fire protection equipment present in the work area. Do not use an open flame to check level or leakage of fuel, battery electrolyte, or coolant.
- i) Properly ventilate the work area in accordance with applicable regulations or local ordinance.

SAFETY INFORMATION

- j) Handle fuel cylinders with care. Physical damage, such as dents, scrapes, or gouges, may dangerously weaken the tank and make it unsafe for use.
- k) Brakes, steering mechanisms, speed and directional control mechanisms, warning devices, lights, governors, guards, and safety devices shall be inspected regularly and maintained in accordance with manufacturer's recommendations.
- l) Special carriers or devices designed and approved for hazardous area operation shall be inspected to ensure that maintenance preserves the original approved safe operating features.
- m) Fuel systems shall be checked for leaks and condition of parts. If a leak is found, action shall be taken to prevent the use to the carrier until the cause of the leak has been repaired.
- n) The carrier manufacturer's capacity, operation, and maintenance instruction plated, tags, or decals shall be maintained in legible condition.
- o) Batteries, motors, speed and directional controllers, limit switches, protective devices, electrical conductors/insulators, and connections shall be inspected and maintained per carrier manufacturer's recommendation.
- p) Carriers shall be kept in a clean condition to minimize hazards and facilitate detection of components needing service.
- q) Modifications and additions which affect capacity and safe carrier operation shall not be performed without manufacturer's prior written authorization; where authorized modifications have been made, the user shall ensure that capacity, operation, warning, and maintenance instruction plates, tags, or safety labels are changed accordingly.
- r) Care shall be taken to ensure that all replacement parts are interchangeable with the original parts and of a quality at least equal to that provided in the original equipment.
- s) Disconnect batteries, negative connection(s) first. When reconnecting, connect positive connection first.
- t) Hydraulic systems, if so equipped, shall be checked for leaks, for condition of parts. Keep body and hands away from pin-holes or nozzles that eject fluids under high pressure. Use paper or cardboard, not hands, to check for leaks.

ANSI/ITSDF B56.8 - 2005

SAFETY INFORMATION

NOTES:

A large grid of graph paper for taking notes, consisting of 20 columns and 30 rows of small squares.

SAFETY INFORMATION

NOTES:

A large grid of graph paper for taking notes, consisting of 20 columns and 30 rows of small squares.

OPERATION AND SERVICE INFORMATION

Read all of Manual to become thoroughly familiar with this vehicle. Pay particular attention to all Notes, Cautions and Warnings

Thank you for purchasing this vehicle. Before driving the vehicle, we ask you to spend some time reading this Owner's Manual and Service Guide. This guide contains the information that will assist you in maintaining this highly reliable vehicle. Some illustrations may show items that are optional for your vehicle. This guide covers the operation of several vehicles; therefore, some pictorial views may not represent your vehicle. Physical differences in controls will be illustrated.

This vehicle has been designed and manufactured as a 'World Vehicle'. Some countries have individual requirements to comply with their specifications; therefore, some sections may not apply in your country.

Most of the service procedures in this guide can be accomplished using common automotive hand tools. Contact your service representative on servicing the vehicle in accordance with the Periodic Service Schedule.

Service Parts Manuals and Technician's Repair and Service Manuals are available from a local Distributor, an authorized Branch or the Service Parts Department. When ordering parts or requesting information for your vehicle, provide vehicle model, serial number and manufacture code.

REFRESHMENT UNIT

The vending unit is equipped with two beverage compartments, a cold storage compartment, a consumable ice compartment, a food display cabinet, two cup dispensers and a trash bin. Available accessories are listed in illustration (Ref Fig. 1 on page 2).

Tool List	Qty. Required
Ratchet, 3/8" drive.....	1
Socket, 1/2", 3/8" drive.....	1
Wrench, 1/2"	1
Phillips screwdriver	1
Wrench, 7/16"	1
Drill.....	1
Socket adapter, 1/4" drive	1
Socket, 5/16", 1/4" drive.....	1

MOUNT VENDING UNIT TO REFRESHMENT VEHICLE

WARNING

The vending unit is heavy. Care and proper lifting equipment and procedures must be used when installing unit to reduce the possibility of severe injury and/or damage to the unit. Be sure hands and fingers are clear of unit while placing unit on frame.

The refreshment unit is shipped on a pallet. While resting on pallet, the unit should be handled with a forklift. If a forklift is not available, be sure an adequate number of assistants are available to safely lift the vending unit.

Orient vending unit so that door on unit will be facing the rear of the vehicle when unit is placed on the mounting frame (Ref Fig. 1 on page 2). Using a forklift, lift the refreshment unit and pallet level with the bed of refreshment vehicle. Lift the refreshment unit off of the pallet and carefully place it onto the mounting frame on vehicle. Align the four mounting holes on refreshment unit with corresponding holes on vehicle mounting frame. Secure unit to frame with four 5/16 - 18 X 1 1/4" bolts (item 1), eight 5/16" flat washers (item 2) and four 5/16 - 18 lock nuts (item 3). Tighten hardware firmly.

FRONT STRUT INSTALLATION

Position front strut (item 4) and braces (item 5) as shown (Ref Fig. 2 on page 3) and secure to vehicle at each side of the cowl with four 5/16 - 18 X 2 1/2" bolts (item 6), four 5/16" lock washers (item 7), two spacers (item 8) and six 3/8" flat washers (item 9). Secure top of braces with two 5/16 - 18 X 2 1/4" bolts (item 10), four 5/16" lock washers (item 11) and two 5/16 - 18 lock nuts (item 12). Attach canopy frame mounting plate (item 13) to front strut using two 1/4 - 20 X 1 1/2" bolts (item 14), four 1/4" flat washers (item 15) and two 1/4 - 20 lock nuts (item 16) as shown. Tighten hardware firmly.

WINDSHIELD AND MIRROR INSTALLATION

WARNING

Typical operation of a Refresher® vehicle on

OPERATION AND SERVICE INFORMATION

Read all of Manual to become thoroughly familiar with this vehicle. Pay particular attention to all Notes, Cautions and Warnings

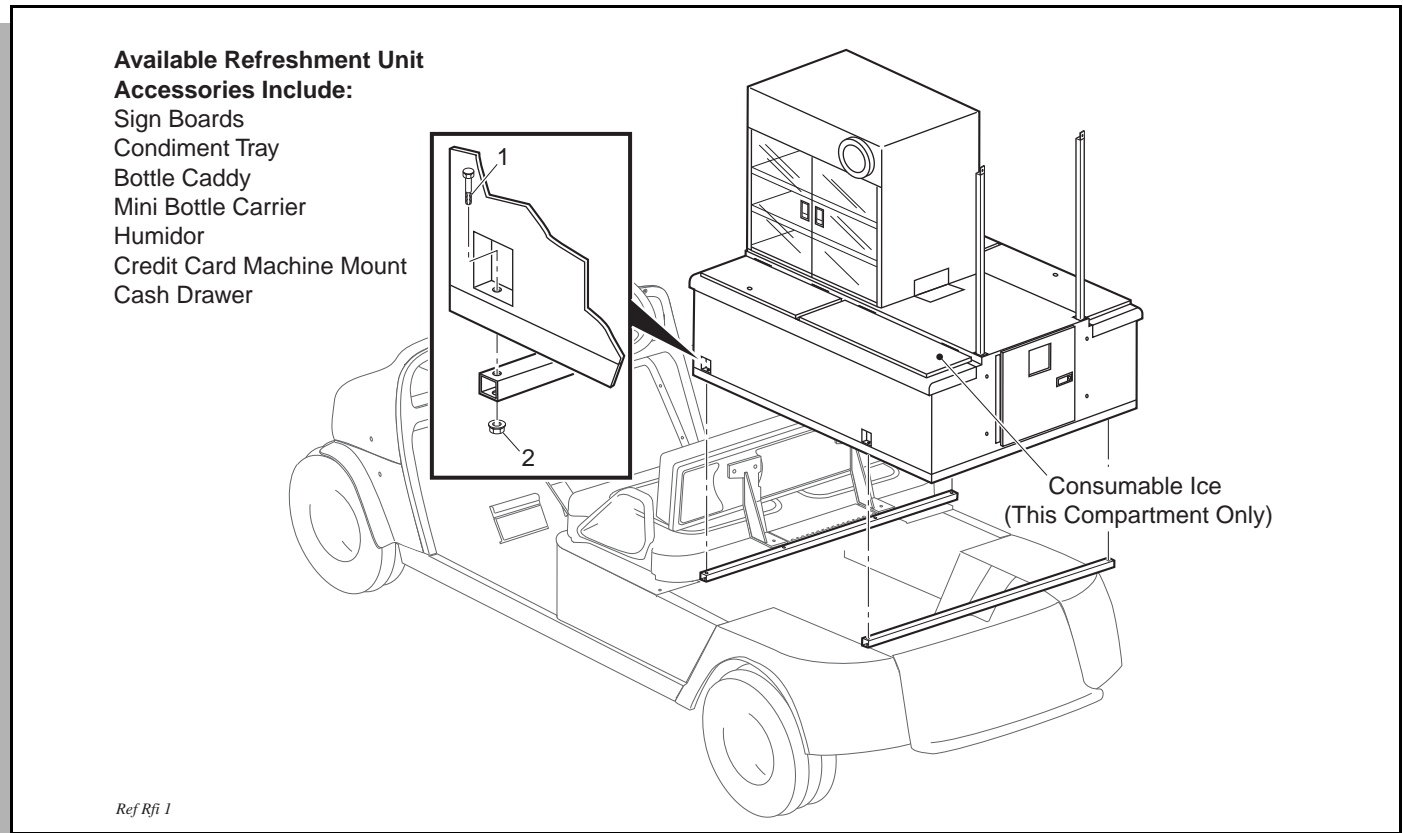

Fig. 1 Mounting the Refreshment Unit

a golf course may expose operator to possibility of being struck by a golf ball. Always operate vehicle with windshield in place.

Insert two bumpers (item 17) and four grommets (item 18) into holes in windshield (item 19) as shown (Ref Fig. 2 on page 3). Position windshield and mirror brackets (item 20) as shown. Secure windshield and mirror brackets to front strut with four 1/4 - 20 X 1 3/4" bolts (item 21), four spacers (item 22), four 1/4" washers (item 23) and four 1/4 - 20 lock nuts (item 24). Tighten hardware firmly. Thread mirrors (item 25) onto mirror brackets and tighten securely.

CANOPY FRAME INSTALLATION

Orient the two canopy frame sections end to end aligning five existing mounting holes as shown (Ref Fig. 3 on page 4) and fasten together with five 1/4 - 20 X 2" bolts (item 26), ten 1/4" flat washers (item 27) and five 1/4 - 20 lock nuts (item 28). Orient the assembled canopy frame as shown and rest front of frame on top mounting plate and rear of frame on refreshment unit struts. Secure canopy frame to refreshment unit struts with two 1/4 - 20 X 1

1/4" bolts (item 29), four 1/4" flat washers (item 30) and two 1/4 - 20 lock nuts (item 31) as shown. Secure canopy frame to front strut with two 1/4 - 20 X 2" bolts (item 32), four 1/4" flat washers (item 33) and two 1/4 - 20 lock nuts (item 34) as shown. Tighten hardware firmly.

CANOPY INSTALLATION

Wipe canopy frame with a clean cloth. Unfold canopy and locate clearance openings in the mounting flap. Drape canopy over frame and orient canopy on frame so that clearance openings match strut attachment points and canopy frame juncture (Ref Fig. 3 on page 4). With the aid of assistants, pull canopy taut over canopy frame. Fold mounting flap up inside canopy frame as shown. Secure each mounting flap to inner surface of canopy frame with #10 X 1/2" self tapping screws (item 35) evenly spaced approximately 9" apart as shown. To prevent "gathering" of canopy material during installation, use the aid of assistants to hold the canopy taut while securing to canopy frame. For best results, begin securing the canopy at the middle of each side and proceed to each end of frame.

OPERATION AND SERVICE INFORMATION

Read all of Manual to become thoroughly familiar with this vehicle. Pay particular attention to all Notes, Cautions and Warnings

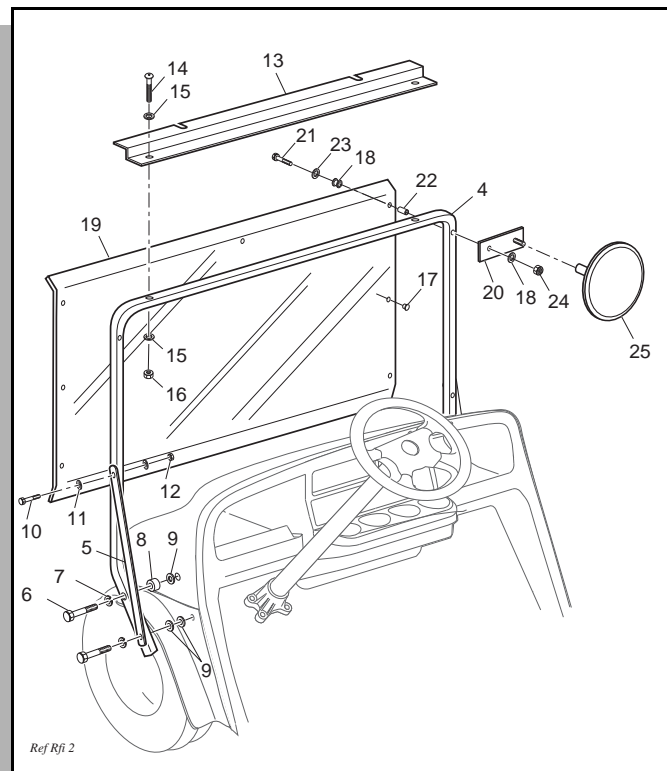

Fig. 2 Front Strut, Windshield and Mirror Installation

DRAIN VALVE INSTALLATION

Locate the drain hose ends and drain valve mounting holes under the rear of unit. Orient each drain valve assembly with spigot facing rearward. Attach each valve assembly to unit with two 1/4 - 20 X 3/4" screws. Slide the hose clamps onto the end of each drain hose. Push the hose ends onto the drain valves and tighten clamps.

REFRESHMENT UNIT REMOVAL

! WARNING

The vending unit is heavy. Care and proper lifting equipment and procedures must be used when removing unit to reduce the possibility of severe injury and/or damage to the unit. Be sure hands and fingers are clear of unit while lowering.

! CAUTION

The drain valves protrude below the frame of the unit

and can be damaged if the unit is removed from pallet and placed directly onto a flat surface. Remove drain valves from refreshment unit before removing unit.

Refreshment unit removal is the reverse order of installation. The unit should be lifted onto a pallet being careful not to damage drains and then handled with a forklift. If a forklift is not available, be sure an adequate number of assistants are available to safely lift the vending unit and pallet.

REFRESHMENT UNIT OPERATION, MAINTENANCE AND CLEANING

Operation

! WARNING

Consumable ice must be stored in the rear driver side compartment only. Clean this compartment and the driver side drain valve before and after each use to reduce the possible contamination of consumable ice.

Canned Beverage Compartments - The canned beverage compartments are designed to carry canned beverages and cooling ice. Cold snacks (sandwiches, fruit, candy etc.) can also be served from these compartments by inserting the product into a plastic food container. Pre-cooling the canned beverages will minimize the amount of ice required to keep the product cool. Maintaining ice in the canned beverage compartment when the container is not in service will help to maintain a colder temperature when the unit is put back into service.

Consumable Ice Compartment - The consumable ice compartment, located in the rear driver side of the beverage container is to be used for consumable ice only (Ref Fig. 1 on page 2). This compartment is equipped with its own drain per FDA requirements and should not be used for canned goods or other products.

Trash Compartment - The trash compartment is located in the rear of the vehicle. The aluminum trash bin should be lined with a disposable plastic bag to maintain cleanliness. The trash bin is removable from the rear door only.

Drains - The two spigot valves, located under the rear of the beverage container, drain the compartments. To open the valves, simply turn the valve handles away from the vehicle (Ref Fig. 4 on page 5). To close the valves, turn the valve handles to a position parallel with the vehicle. It

OPERATION AND SERVICE INFORMATION

Read all of Manual to become thoroughly familiar with this vehicle. Pay particular attention to all Notes, Cautions and Warnings

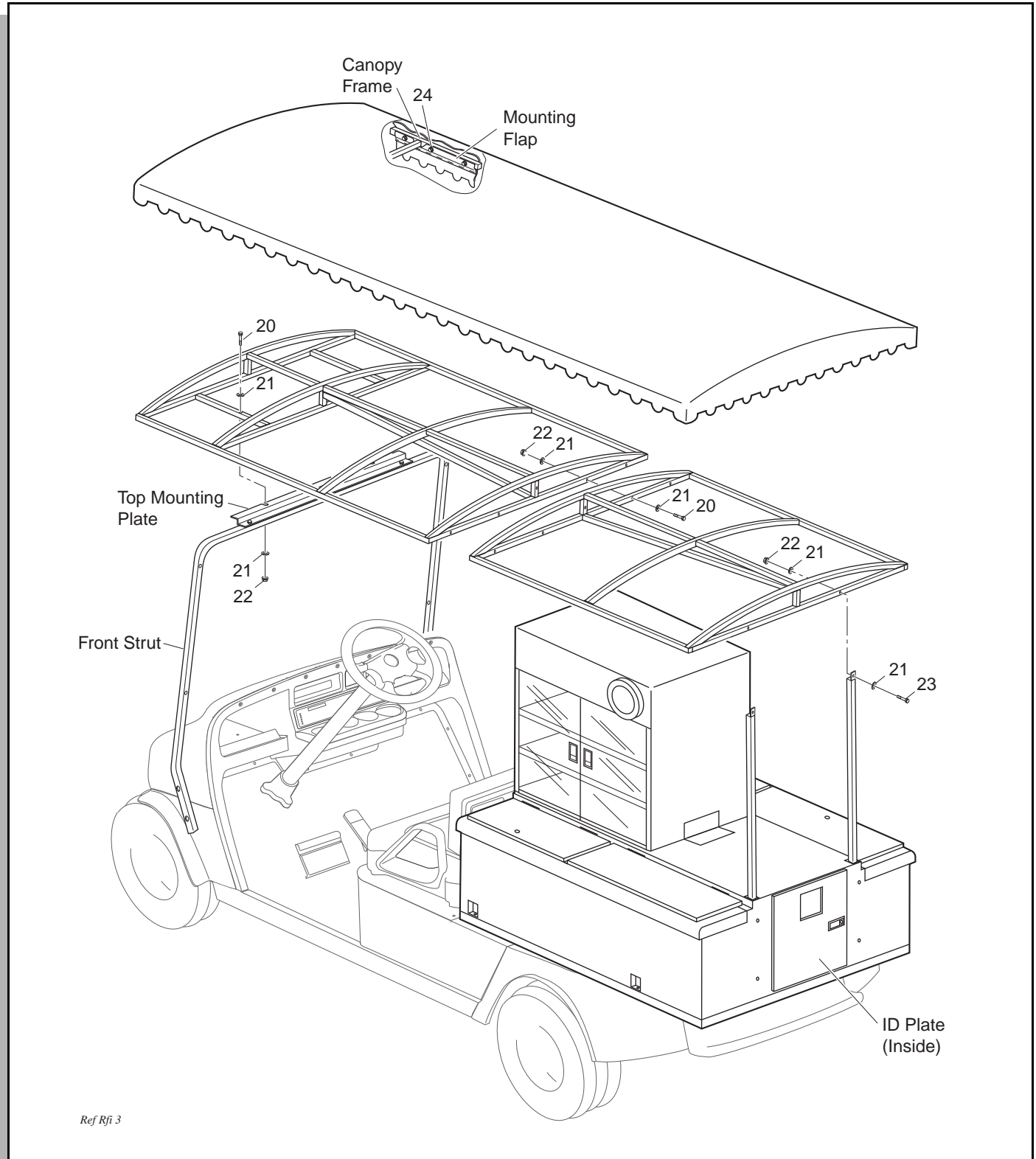

Fig. 3 Canopy Installation

OPERATION AND SERVICE INFORMATION

Read all of Manual to become thoroughly familiar with this vehicle. Pay particular attention to all Notes, Cautions and Warnings

is recommended that the valves be left in an open position while the vehicle is in service.

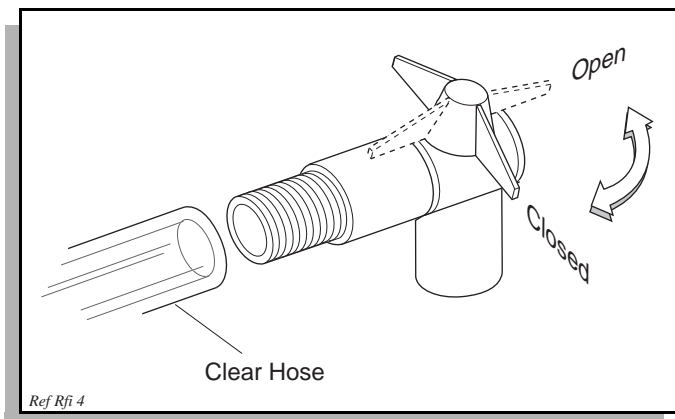

Fig. 4 Emptying Water from Bins

Cup Dispensers - The cup dispensers are designed to carry cups ranging from 14 to 20 ounces. To adjust the cup dispenser for your size and type of cup, remove the outer collar, insert a sleeve of cups into the dispenser, and turn the adjusting screw until the cups are securely held in the cup dispenser. Re-install the outer collar.

Shelves are to be used for any type of dry good such as chips, peanuts, hats, golf balls etc.

Air Pot - The three one gallon Air Pots are for serving hot or cold beverages.

Cleaning

Interior Aluminum Surfaces - The interior surfaces should be cleaned on a daily basis using a soap and water solution. Thoroughly rinse after cleaning.

Exterior Painted Surfaces - The painted surfaces should be cleaned on a daily basis using a soap and water solution.

Exterior Aluminum Surfaces - The aluminum surfaces should also be cleaned on a daily basis using a soap and water solution. Periodic cleaning with an aluminum or stainless steel cleaner is recommended. We recommend ZEP Stainless Steel Polish or equal.

Drains - The drains should be flushed with a hose on a daily basis. Periodically, the drains should be cleaned and sanitized.

Acrylic - The clear acrylic doors should be cleaned daily with a soap and water solution. Dry with a clean damp chamois. Do not use window-cleaning sprays.

Polypropylene - The polypropylene doors should be cleaned daily with a soap and water solution.

Canopy Cover - Periodically hose off the fabric with fresh water and allow to dry on the canopy frame.

Maintenance

The door latches and locks will require periodic tightening, adjusting and lubricating with a silicone spray lubricant. We recommend that this be done every two weeks. Tightening of all screws, nuts and bolts should be accomplished on a regular basis.

REFRESHMENT UNIT REPLACEMENT PARTS

When ordering refreshment unit replacement parts, reference manufacturer's I. D. plate located in trash bin compartment.

BEFORE INITIAL USE

Read, understand and follow the safety label on the instrument panel. Be sure you understand how to operate the vehicle, its equipment and how to use it safely. Maintaining good performance depends to a large extent on the operator.

WARNING

Hydrogen gas is generated as a natural part of the lead acid battery charging process. A 4% concentration of hydrogen gas is explosive and could cause severe injury or death. Charging must take place in an area that is adequately ventilated (minimum of 5 air exchanges per hour).

To reduce the chance of battery explosion that could result in severe injury or death, never smoke around or charge batteries in an area that has open flame or electrical equipment that could cause an electrical arc.

Before a new vehicle is put into operation, the items shown in the INITIAL SERVICE CHART must be performed (Ref Fig. 5 on page 6).

Vehicle battery must be fully charged before initial use.

Check for correct tire inflation. See GENERAL SPECIFICATIONS.

Check for oil or fuel leaks that could have developed in shipment from the factory.

OPERATION AND SERVICE INFORMATION

Read all of Manual to become thoroughly familiar with this vehicle. Pay particular attention to all Notes, Cautions and Warnings

Determine and record braking distance required to stop vehicle for future brake performance tests.

Remove the protective clear plastic, that protect the seat bottom and back rest during shipping, before placing the vehicle in service.

ITEM	SERVICE OPERATION
Battery	Charge battery
Seats	Remove protective plastic covering
Brakes	Check operation and adjust if necessary
	Check hydraulic brake fluid level if equipped
	Establish acceptable stopping distance
Tires	Check air pressure (see SPECIFICATIONS)
Fuel	Fill tank with correct fuel
Engine	Check oil level

Ref Isc 6

Fig. 5 Initial Service Chart

CONTROLS AND INDICATORS

Vehicle controls and indicators consist of:

- key/light switch
- direction selector
- choke
- fuel gauge
- low oil pressure indicator light
- accelerator pedal
- combination service and park brake pedal with front disc brakes (optional)
- horn

KEY/LIGHT SWITCH

Located on the dash panel, this switch enables the basic electrical system of the vehicle to be turned on and off by turning the key. To prevent inadvertent operation of the vehicle when left unattended, the key should be turned to the 'OFF' position and removed (Ref Fig. 6 on page 6).

If the vehicle is equipped with lights, the key switch has a position to operate them, indicated by the light icon.

NOTE

If the vehicle is equipped with factory installed custom accessories, some accessories remain operational with the key switch in the 'OFF' position.

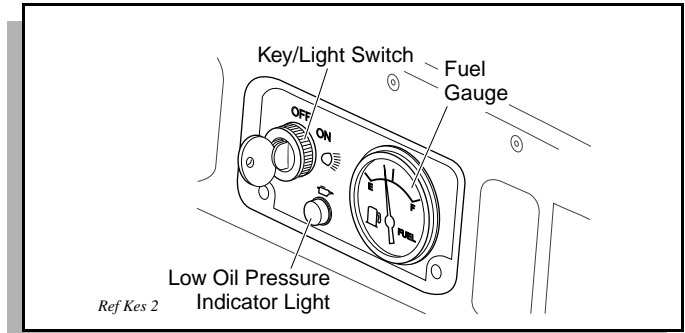

Fig. 6 Key/Light Switch, Low Oil Pressure Light and Fuel Gauge

DIRECTION SELECTOR



To reduce the possibility of component damage, the vehicle must be completely stopped before moving the direction selector.

Located on the seat support panel, this lever permits the selection of either 'F' (forward) or 'R' (reverse) (Ref Fig. 7 on page 6). Vehicle should be left in 'F' when unattended.

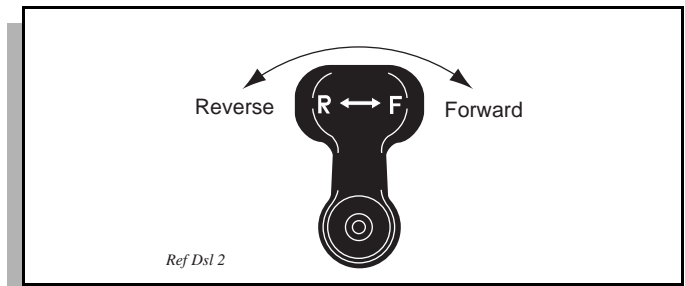

Fig. 7 Direction Selector

CHOKE

The choke is used to aid cold starting (Ref. Fig. 8 on page 7). See COLD STARTING section for operating instructions.

FUEL GAUGE

The fuel gauge (if equipped) will either be located on the dash panel (electric) (Ref Fig. 6 on page 6) or directly on the fuel tank (mechanical).

OPERATION AND SERVICE INFORMATION

Read all of Manual to become thoroughly familiar with this vehicle. Pay particular attention to all Notes, Cautions and Warnings

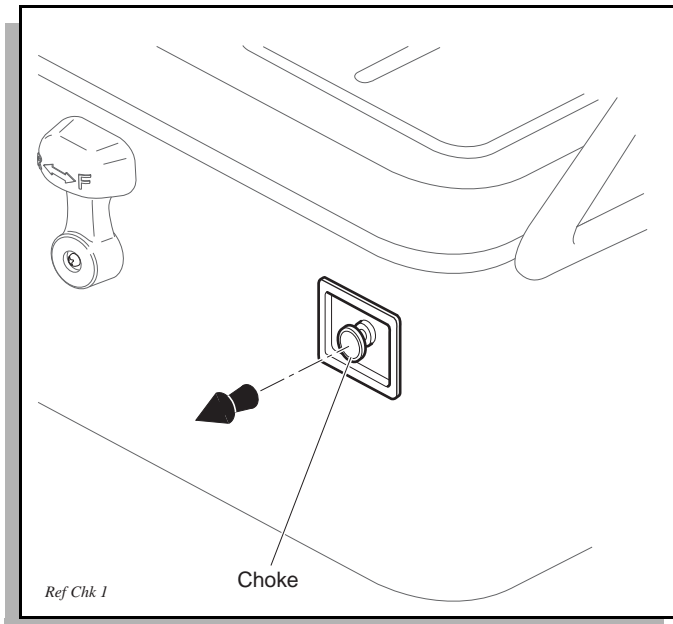

Fig. 8 Choke

LOW OIL PRESSURE INDICATOR LIGHT

A low oil pressure indicator light is located on the dash panel (Ref Fig. 6 on page 6). The light illuminates when the oil pressure is low. Check oil level. If oil level is between ADD and FULL mark on dipstick, a mechanical problem exists within the engine and the vehicle **must not be driven**. Contact a local distributor or authorized branch.



CAUTION

To prevent engine damage, do not operate engine until oil pressure is corrected. Do not overfill engine. Too much oil may cause smoking or allow oil to enter the air filter enclosure.

If oil level is below ADD mark on dipstick, add oil to bring level to FULL mark. Drive vehicle a short distance and check oil pressure. If oil light does not come on, continue to use vehicle.

ACCELERATOR PEDAL



WARNING

Unintentional movement of the accelerator pedal will release the park brake and may

cause the vehicle to move which could result in severe injury or death.

With the key switch 'ON', depressing the accelerator pedal starts the engine. When the pedal is released, the engine will stop (Ref Fig. 9 on page 7). To stop the vehicle more quickly, depress the service brake.

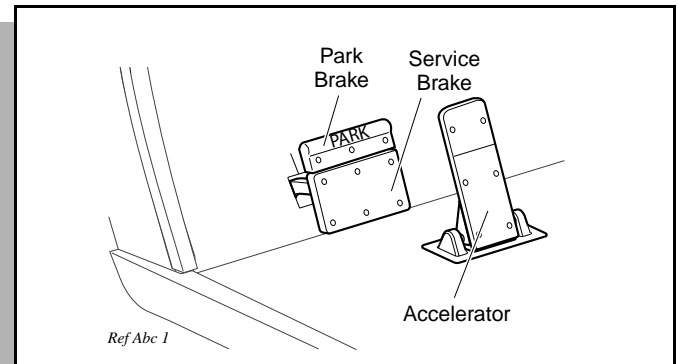

Fig. 9 Accelerator and Brake Controls

If key switch is 'ON' and park brake is set, depressing the accelerator inadvertently will release the park brake and will cause the vehicle to move which could cause severe injury or death.

Depressing the accelerator pedal will release the park brake if it is engaged. This is a feature to assure the vehicle is not driven with the park brake engaged. Depressing the accelerator pedal is **not** the preferred method of releasing the park brake.

NOTE

Depressing the **lower section of the brake pedal** is the preferred method of releasing the park brake to assure the longest service life of brake components.

COMBINATION SERVICE AND PARK BRAKE PEDAL

The brake pedal incorporates a park brake feature (Ref Fig. 9 on page 7). To engage, push down on the upper section of the pedal until it locks in place. The park brake will release when the service brake pedal is depressed. Use the lower section of the brake pedal to operate the service brake system.

OPTIONAL FRONT DISC BRAKES

The front disc brakes activate as the brake pedal reaches the 'park' or 'latch' position. Depressing the

OPERATION AND SERVICE INFORMATION

Read all of Manual to become thoroughly familiar with this vehicle. Pay particular attention to all Notes, Cautions and Warnings

brake pedal further will increase the effectiveness of the front brakes.

HORN

The horn is operated by pushing the horn button located on the floor to the left of the brake pedal (Ref Fig. 10 on page 8).

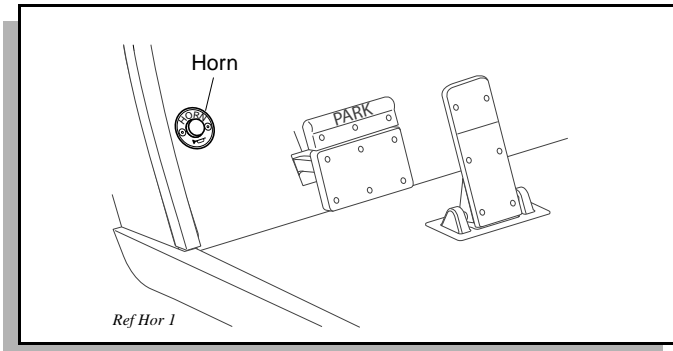

Fig. 10 Horn Button

OPERATING THE VEHICLE

CAUTION

Improper use of the vehicle or the lack of proper maintenance may result in damage or decreased performance.

Read and understand the following warnings before attempting to operate the vehicle.

WARNING

To reduce the possibility of severe injury or death resulting from loss of vehicle control, the following warnings must be observed:

When driving vehicle, consider the terrain, traffic conditions and the environmental factors which effect the terrain and the ability to control the vehicle.

Use extra care and reduced speed when driving on poor surfaces, such as loose dirt, wet grass, gravel, etc.

Stay in designated areas and avoid extremely rough terrain.

Maintain a safe speed when driving

down hill. Use service brake to control speed when traveling down an incline. A sudden stop or change of direction may result in loss of control.

Slow down before and during turns. All turns should be made at reduced speed.

Never drive vehicle up, down, or across an incline that exceeds 14° (25% grade).

WARNING

To reduce the possibility of severe injury or death resulting from improper vehicle operation, the following warnings must be observed:

Refer to GENERAL SPECIFICATIONS for seating capacity.

Depressing accelerator pedal will release foot operated park brake and may cause inadvertent vehicle movement. Turn the key to the 'OFF' position whenever the vehicle is parked.

To prevent inadvertent movement when the vehicle is to be left unattended, engage the park brake, move direction selector to forward position, turn key to 'OFF' position and remove key.

Make sure that the direction selector is in correct position before attempting to start the vehicle.

Always bring the vehicle to a complete stop before shifting the direction selector.

Do not take vehicle out of 'gear' while in motion (coast).

Check the area behind the vehicle before operating in reverse.

All occupants must be seated. Keep entire body inside vehicle and hold on while vehicle is in motion.

RUN-IN

Check for oil or fuel leaks that could have developed in shipment from the factory. Avoid full throttle starts and

OPERATION AND SERVICE INFORMATION

Read all of Manual to become thoroughly familiar with this vehicle. Pay particular attention to all Notes, Cautions and Warnings

rapid acceleration until the engine has achieved operating temperature.

All engines consume more oil than normal during the first hours of operation. As internal moving parts are run-in, oil consumption should gradually decrease until the rate of consumption stabilizes.

Check the oil level per the Periodic Service Schedule. Add oil if the level on the dipstick indicates that oil is in the add oil range (Ref Fig. 20 on page 18).

CAUTION

Do not overfill engine. Too much oil may cause smoking or allow oil to enter the air filter enclosure.

NOTE

Both the oil dipstick and fill cap must be in place before operating the engine. Failure to install the dipstick and fill cap will result in oil becoming contaminated and/or being discharged into the engine compartment.

Oil Dipsticks are unique to this model vehicle. Do not interchange oil dipsticks between models.

The oil should be changed in accordance with the Periodic Service Schedule while the engine is warm. See SERVICE AND MAINTENANCE for checking oil level and changing oil procedures.

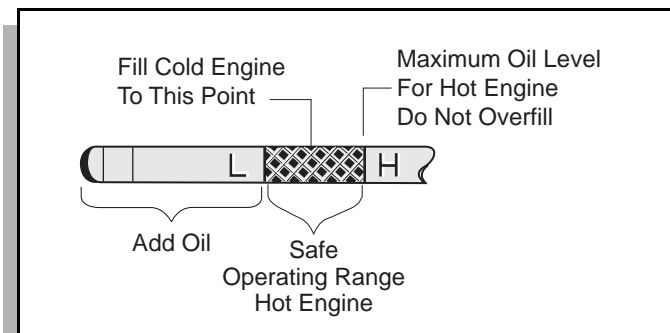

Fig. 11 Check Oil Level on Dipstick

COLD STARTING

Starting a cold engine may require use of the choke. Depress the accelerator approximately 1" (2.5 cm) or until the starter just begins to operate. Pull the choke out if required. Accelerate slowly and push the choke in completely when the engine runs smoothly.

CAUTION

Do not allow the starter to operate continuously for more than 10 seconds. Allow 30 seconds between starting attempts. If the vehicle does not start on the third attempt, turn the key switch off, set the park brake and determine the cause of the problem.

If the vehicle had been running and the engine does not start within 10 seconds, use the choke.

STARTING AND DRIVING

WARNING

To reduce the possibility of roll-back which could result in severe injury or vehicle damage, do not release service brake until engine has started.

To operate vehicle:

- Apply the service brake, place the key in the key switch and turn it to the 'ON' position.
- Move the direction selector to the direction desired.
- Release the park brake by depressing the service brake pedal until the park brake releases.
- Slowly depress the accelerator pedal to start the engine. Release service brake when engine starts.
- When the accelerator pedal is released, the ignition circuit is de-energized and the engine stops. To stop the vehicle more quickly, depress the service brake pedal.

NOTE

When the direction selector is in the reverse position, a warning signal will sound to indicate that the vehicle is ready to run in reverse.

STARTING THE VEHICLE ON A HILL

WARNING

To reduce the possibility of roll-back which could result in severe injury or vehicle dam-

OPERATION AND SERVICE INFORMATION

Read all of Manual to become thoroughly familiar with this vehicle. Pay particular attention to all Notes, Cautions and Warnings

age, do not release service brake until engine has started.

CAUTION

Do not hold vehicle on hill by using accelerator and engine. This will cause premature and excessive wear to drive train components.

To reduce the possibility of permanent damage to the drive system, it is important to prevent excessive roll-back when starting the vehicle on a hill.

Place left foot on service brake and release the park brake. Depress accelerator with right foot and release the service brake by lifting left foot.

COASTING

WARNING

To reduce the possibility of severe injury or death from coasting at above recommended speeds, limit speed with service brake.

On steep hills, it is possible for the vehicle to coast at greater than normal speeds encountered on a flat surface. To reduce the possible loss of vehicle control and severe drivetrain damage, speeds should be limited to no more than the maximum governed speed on level ground (see GENERAL SPECIFICATIONS). Limit speed by applying service brake.

FUEL

WARNING

To reduce the possibility of severe injury or death from improper fuel handling:

Do not smoke near the fuel tank.

Do not refuel near open flame or electrical items which could produce a spark.

Always handle gasoline in a well ventilated area.

Always wear eye protection to protect against splashed fuel and fuel vapors.

Always allow adequate space for the expansion of gasoline. Leave at least 1" (2.5 cm) space below bottom of filler neck.

Inspect fuel cap, tank and other components for leaks or deterioration that could cause a hazardous condition.

The fuel tank is located under the seat on the passenger side of the vehicle (Ref Fig. 12 on page 10). Fill the tank with fresh, clean, automotive grade gasoline (Ref Fig. 39 on page 28). High altitude or heavy use/load applications may benefit from higher octane gasoline.

Do not use gasoline which contains Methanol.

CAUTION

Some fuels, called oxygenated or reformulated gasoline, are gasoline blended with alcohols or ethers. Excessive amounts of these blends can damage the fuel system or cause performance problems. If any undesirable operating symptoms occur, use gasoline with a lower percentage of alcohol or ether.

Use fresh regular grade unleaded fuel. Ethanol blend fuels upto 10% are permissible

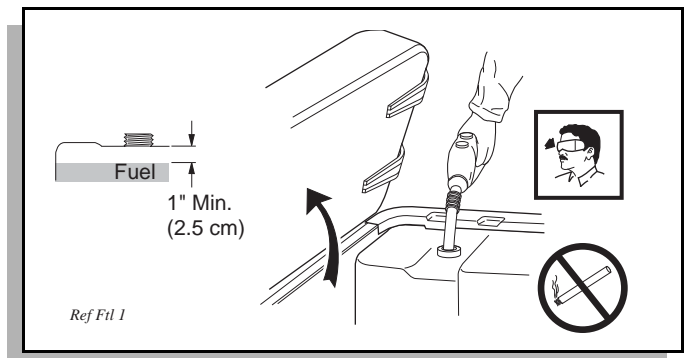

Fig. 12 Fueling

BATTERY

CAUTION

Excessive use of accessories may drain the battery and leave insufficient reserve to start the vehicle.

The vehicle uses a combination starter/generator to both start the engine and charge the battery. The engine will not idle; therefore, the battery cannot be charged while

OPERATION AND SERVICE INFORMATION

Read all of Manual to become thoroughly familiar with this vehicle. Pay particular attention to all Notes, Cautions and Warnings

the vehicle is stopped. Do not operate accessory items (such as accessory lights, radios, winch, etc.) excessively while the vehicle is stopped.

The generator is capable of supplying 35 amps; therefore, operation of all accessories could result in the discharge of the battery even though the engine is running and the generator operating. Discharging the battery is known as deep cycling. The battery is not a deep cycle model, but is a starting battery. Multiple deep cycling will result in the premature failure of the battery.

If the vehicle battery has become discharged, it must be charged using a 12 volt charger that is rated at 10 amps or less and in accordance with all instructions provided by the manufacturer of the charger.

LABELS AND PICTOGRAMS

Vehicles may be labeled with pictograms as a method of conveying information or warnings. Appendix A illustrates and explains pictograms that may appear on the vehicle. Not all pictograms shown in Appendix A will be found on your vehicle.

SUN TOP AND WINDSHIELD

WARNING

The sun top does not provide protection from roll over or falling objects.

The windshield does not provide protection from tree limbs or flying objects.

CAUTION

To prevent damage to the vehicle, do not hold on to sun top struts and stand on body panels.

The sun top and windshield provide some protection from the elements; however, they will not keep the operator and passenger dry in a downpour. This vehicle is not equipped with seat belts and the sun top has not been designed to provide roll over protection. In addition, the sun top does not protect against falling objects nor does the windshield protect against flying objects and tree limbs. Keep arms and legs inside of vehicle while it is moving.

12 VOLT POWER OUTLET

CAUTION

Overuse of accessories may drain the battery and leave insufficient reserve to start the vehicle.

A 12 volt power outlet, rated at 15 amps, is located to the left side of the key/light switch (Ref Fig. 13 on page 11). It provides constant power for accessories equipped with a 12 volt plug.

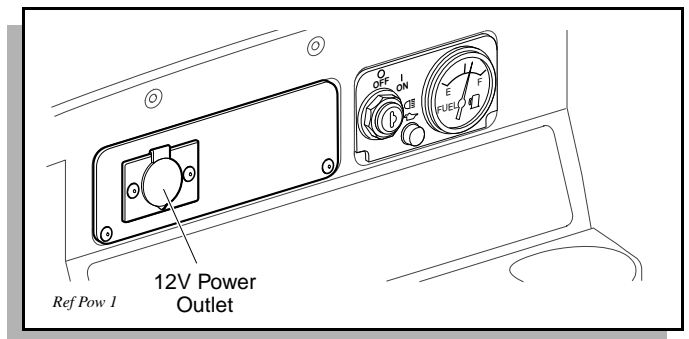

Fig. 13 12 Volt Power Outlet

TOWING A TRAILER

The vehicle is equipped with a receiver that can be fitted with a standard 1 7/8" ball. The trailer and its load must not exceed 500 lbs (227 kg) and no more than 50 lbs (23 kg) tongue weight may be attached to the hitch. Remember that the overall capacity of the vehicle, operator, passenger, contents of load bed and accessories must be reduced to compensate for the trailer and load.

The range of motion of the trailer is limited by the ball and hitch. The trailer should not be used on rough trails or over objects such as logs, large rocks, holes, etc.

Never install baskets or extensions using the hitch receivers (front or rear). Such items will change the performance characteristics of vehicle and result in unsafe handling, possible roll over or vehicle damage.

VEHICLE CLEANING AND CARE

VEHICLE CLEANING

WARNING

To reduce the possibility of severe injury or

OPERATION AND SERVICE INFORMATION

Read all of Manual to become thoroughly familiar with this vehicle. Pay particular attention to all Notes, Cautions and Warnings

vehicle damage, read and understand all instructions supplied by manufacturer of pressure washer.



CAUTION

When pressure washing exterior of vehicle, do not use pressure in excess of 700 psi. To reduce the possibility of cosmetic damage, do not use any abrasive or reactive solvents to clean plastic parts.

It is important that proper techniques and cleaning materials be used. Using excessive water pressure may cause severe injury to operator or bystander, damage to seals, plastics, seat material, body finish or electrical system. Do not use pressure in excess of 700 psi to wash exterior of vehicle.

Clean windshield with lots of water and a clean cloth. Minor scratches may be removed using a commercial plastic polish or Plexus[®] plastic cleaner available from the service parts department.

Normal cleaning of vinyl seats and plastic or rubber trim requires the use of a mild soap solution applied with a sponge or soft brush and wipe with a damp cloth.

Removal of oil, tar, asphalt, shoe polish, etc. will require the use of a commercially available vinyl/rubber cleaner.

The painted surfaces of the vehicle provide attractive appearance and durable protection. Frequent washing with lukewarm or cold water and mild detergent is required to preserve the painted surfaces.

Occasional cleaning and waxing with non-abrasive products designed for 'clear coat' automotive finishes will enhance the appearance and durability of the painted surfaces.

Corrosive materials used as fertilizers or for dust control can collect on the underbody of the vehicle. These materials will cause corrosion of underbody parts unless flushed occasionally with plain water. Thoroughly clean any areas where mud or other debris can collect. Sediment packed in closed areas should be loosened to ease it's removal, taking care not to chip or otherwise damage paint.

NOTE

If the engine does not start or runs improperly after washing, remove the spark plug wires (by pulling the spark plug boots, never the wires). Dry all connections with forced air. Reinstall the wires.

REPAIR

LIFTING THE VEHICLE

Tool List	Qty. Required
Floor jack	1
Jack stands.....	4
Chocks.....	4

Some servicing operations may require the front wheels, the rear wheels, or the entire vehicle be raised.



WARNING

To reduce the possibility of severe injury or death from a vehicle falling from a jack:

Be sure the vehicle is on a firm and level surface.

Never get under a vehicle while it is supported by a jack.

Use jack stands and test the stability of the vehicle on the stands.

Always place chocks in front and behind the wheels not being raised.

Use extreme care since the vehicle is extremely unstable during the lifting process.



CAUTION

When lifting vehicle, position jacks and jack stands at the areas indicated only.

To raise the entire vehicle, install chocks in front and behind each front wheel (Ref Fig. 14 on page 13). Center the jack under the rear frame crossmember. Raise the vehicle enough to place a jack stand under the outer ends of the rear axle.

Lower the jack and test the stability of the vehicle on the two jack stands.

Place the jack at the center of the front axle. Raise the vehicle enough to place jack stands under the frame crossmember as indicated.

Lower the jack and test the stability of the vehicle on all four jack stands.

OPERATION AND SERVICE INFORMATION

Read all of Manual to become thoroughly familiar with this vehicle. Pay particular attention to all Notes, Cautions and Warnings

If only the front or rear of the vehicle is to be raised, place the chocks in front and behind each wheel not being raised to stabilize the vehicle.

Lower the vehicle by reversing the lifting sequence.

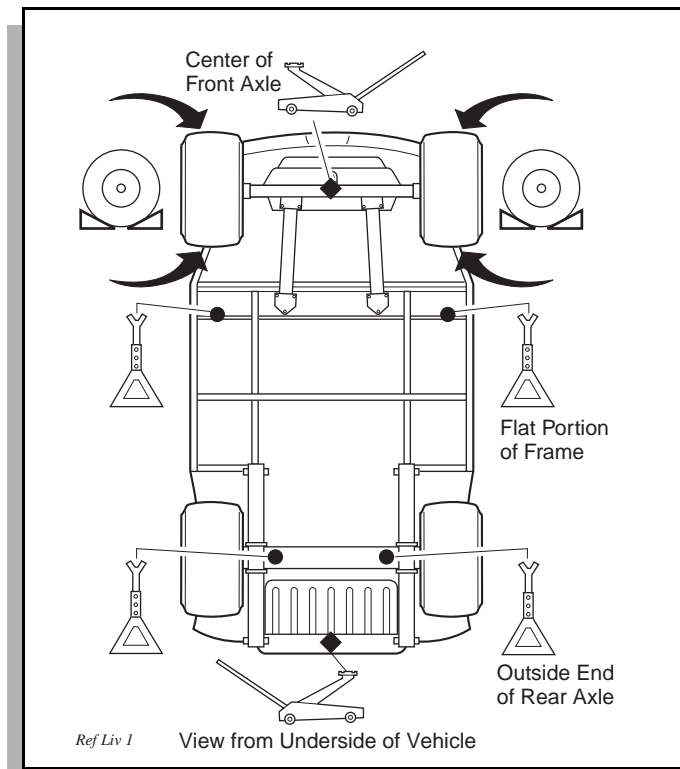

Fig. 14 Lifting the Vehicle

WHEELS AND TIRES

Tire Repair

Tool List	Qty. Required
Lug wrench, 3/4"	1
Impact socket, 3/4", 1/2" drive.....	1
Impact wrench, 1/2" drive.....	1
Torque wrench, 1/2" drive	1

⚠ WARNING

A tire explosion can cause severe injury or death. Never exceed inflation pressure rating on tire sidewall.

To reduce the possibility of tire explosion, pressurize tire with small amount

of air applied intermittently to seat beads. Due to the low volume of the small tires, overinflation can occur in seconds. Never exceed the tire manufacturer's recommendation when seating a bead. Protect face and eyes from escaping air when removing valve core.

To reduce the possibility of severe injury caused by a broken socket when removing wheels, use only sockets designed for impact wrench use.

Use caution when inflating tires. Overinflation could cause the tire to separate from the wheel or cause the tire to explode, either of which could cause severe injury.

Do not use low inflation pressure tires on any E-Z-GO vehicle. Do not use any tire which has a recommended inflation pressure less than the inflation pressure recommended in Owner's Manual.

Use caution when inflating tires. Due to the low volume of the small tires, overinflation can occur in seconds. Overinflation could cause the tire to separate from the wheel or cause the tire to explode.

Tire inflation should be determined by the condition of the terrain. See GENERAL SPECIFICATIONS section for recommended tire inflation pressure. For outdoor applications with major use on grassy areas, the following should be considered. On hard turf, it is desirable to have a **slightly** higher inflation pressure. On very soft turf, a lower pressure reduces the possibility of tires cutting into the turf. For vehicles being used on paved or hard surfaces, tire inflation pressure should be in the higher allowable range, but under no condition should inflation pressure be higher than recommended on tire sidewall. **All four tires** should have the same pressure for optimum handling characteristics. Be sure to install the valve dust cap after checking or inflating.

The vehicle is fitted with low pressure tubeless tires mounted on one piece rims; therefore, the most cost effective way to repair a puncture in the tread is to use a commercial tire plug.

NOTE

Tire plug tools and plugs are available at most automotive parts outlets and have the advantage of not requiring the tire be

OPERATION AND SERVICE INFORMATION

Read all of Manual to become thoroughly familiar with this vehicle. Pay particular attention to all Notes, Cautions and Warnings

removed from the wheel.

If the tire is flat, remove the wheel and inflate the tire to the maximum recommended pressure for the tire. Immerse the tire in water to locate the leak and mark with chalk. Insert tire plug in accordance with manufacturer's instructions.

⚠️ WARNING

To reduce the possibility of severe injury, be sure mounting/demounting machine is anchored to floor. Wear OSHA approved safety equipment when mounting/demounting tires.

If the tire is to be removed or mounted, the tire changing machine manufacturer's recommendations must be followed in order to reduce possibility of severe injury.

Wheel Installation

⚠️ CAUTION

To reduce the possibility of component damage, do not tighten lug nuts to more than 85 ft. lbs. (115 Nm) torque.

NOTE

It is important to follow the 'cross sequence' pattern when installing lug nuts. This will assure even seating of the wheel against the hub.

With the valve stem to the outside, mount the wheel onto the hub with lug nuts. Finger tighten lug nuts in a 'cross sequence' pattern (Ref Fig. 15 on page 14) . Tighten lug nuts to 50 - 85 ft. lbs. (70 - 115 Nm) torque in 20 ft. lbs. (30 Nm) increments following the 'cross sequence' pattern.

LIGHT BULB REPLACEMENT

⚠️ CAUTION

To reduce the possibility of premature bulb failure, do not touch new bulbs with bare fingers. Use clean, dry tissue or paper towel to handle the glass portion of the bulb.

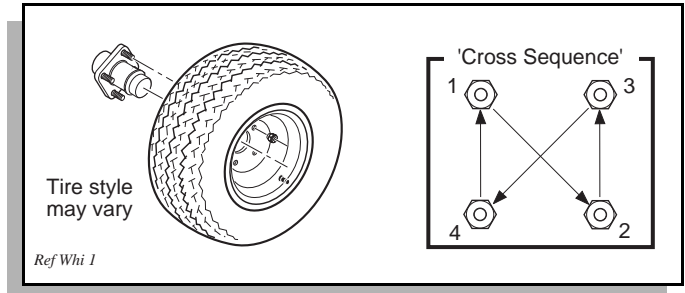

Fig. 15 Wheel Installation

For vehicles with headlights mounted in cowl, locate the two screws on backside of cowl that secure headlight (Ref Fig. 16 on page 14). Remove screws, pull headlight out and disconnect wires. Connect wires to new headlight, install in cowl and secure with screws previously removed.

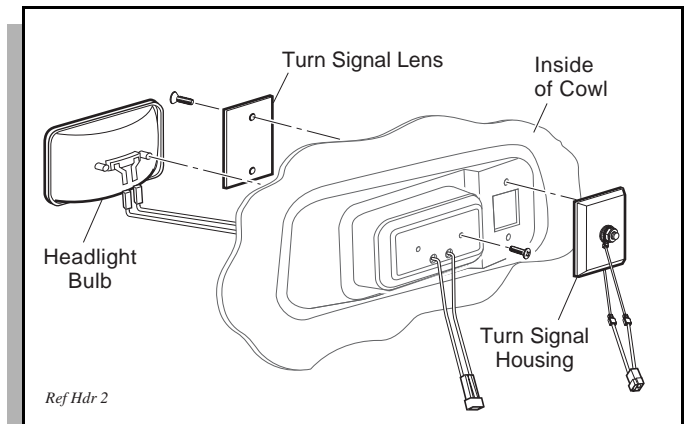

Fig. 16 Headlight and Turn Signal Bulb Replacement

To replace the turn signal light bulb, support turn signal housing from backside of cowl while removing two screws securing lens. Install new bulb and replace lens.

To replace the tail and brake light bulb, roll the rubber bezel from around the edge of the taillight and remove lens. Install replacement bulb and replace lens.

FUSE REPLACEMENT

To replace fuses, locate the fuse block under the driver side seat. Pull out old fuse and replace with a new automotive type fuse. Headlight and taillight bulbs and fuses are available from a local Distributor, an authorized Branch or the Service Parts Department.

OPERATION AND SERVICE INFORMATION

Read all of Manual to become thoroughly familiar with this vehicle. Pay particular attention to all Notes, Cautions and Warnings

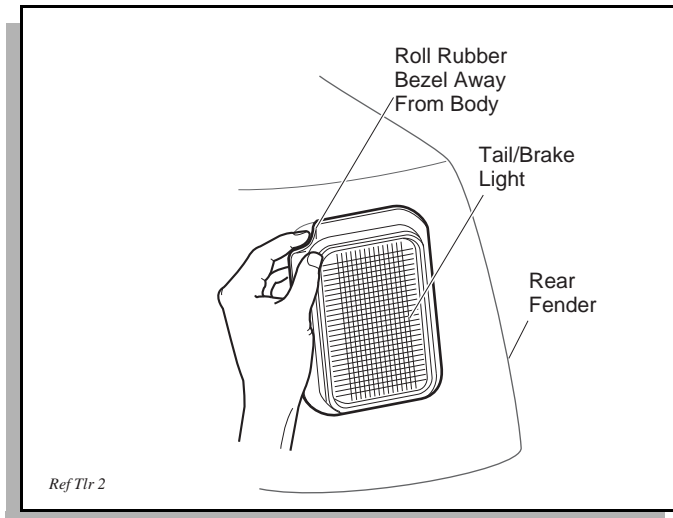

Fig. 17 Tail and Brake Light Bulb Replacement

VEHICLE WITH A DISCHARGED BATTERY

! WARNING

To reduce the possibility of severe injury or death from inadvertent motion, do not attempt to 'jump start' a vehicle.

The vehicle is equipped with a starter/generator and does not idle. When starting the engine, the starter/generator functions as a starter and with the engine running, it functions as a generator.

With the short running times associated with this kind of vehicle, the generator is more than adequate to maintain the battery charge level. The generator is not designed to charge a discharged battery.

When engine starts, the clutches engage and cause vehicle to move making 'jump starting' both dangerous and impractical.

If the vehicle battery has become discharged, it must be charged using a 12 volt charger that is rated at 10 amps or less. Read and understand all instructions provided by the manufacturer of the charger.

TRANSPORTING VEHICLE

TOWING

! WARNING

This vehicle is not designed to be towed.

It is recommended that the vehicle be moved by placing the entire vehicle on a trailer, flatbed truck or other suitable transport.

NEUTRAL LOCK

To prevent the driven clutch from turning the rear wheels during service operations, a neutral lock is located on the direction selector.

To operate:

Turn key switch to 'OFF' and lift seat. Pull out and rotate the neutral lock pin handle so that the pointed portion of the handle is to the side of the direction selector cam (Ref Fig. 18 on page 15). Move direction selector towards the area between 'F' and 'R'. During that motion, the pin will snap into the hole in the direction selector mounting bracket preventing any movement. When in this position, the direction selector remains locked in the neutral position. To unlock the direction selector, pull the neutral lock pin handle out and rotate until the pointed portion of the handle fits into the hole in the direction selector cam.

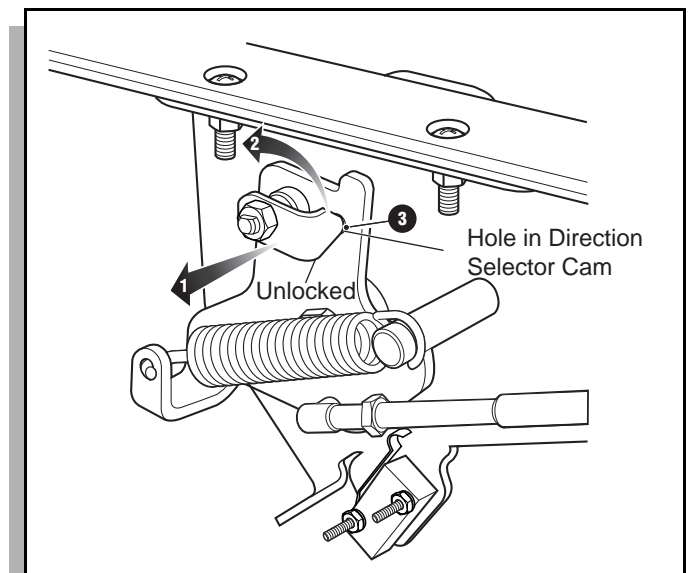

Fig. 18 Neutral Lock

OPERATION AND SERVICE INFORMATION

Read all of Manual to become thoroughly familiar with this vehicle. Pay particular attention to all Notes, Cautions and Warnings

HAULING

WARNING

To reduce the possibility of severe injury or death while transporting vehicle:

Secure the vehicle and contents.

Never ride on vehicle being transported.

Always remove windshield before transporting.

Maximum speed with sun top installed is 50 mph (80 kph).

If the vehicle is to be transported at highway speeds, the sun top must be removed and the seat bottom secured. When transporting vehicle below highway speeds, check for tightness of hardware and cracks in sun top at mounting points. Always remove windshield when transporting. Always check that the vehicle and contents are adequately secured before transporting. The rated capacity of the trailer or truck must exceed the weight of the vehicle (see GENERAL SPECIFICATIONS for vehicle weight) and load. Lock the park brake and secure the vehicle using ratchet tie downs.

SERVICE AND MAINTENANCE

WARNING

To reduce the possibility of severe injury or death from improper servicing techniques:

Do not attempt any type of servicing operations before reading and understanding all notes, cautions and warnings in this manual.

Any servicing requiring adjustments to be made to the powertrain while the engine is running must be made with both drive wheels raised and vehicle properly supported on jack stands.

To reduce the possibility of engine damage, never operate vehicle at full throttle for more than 4 - 5 seconds while vehicle is in a 'no load' condition.



Wear eye protection when working on the vehicle. Use extra care when working around batteries, or using solvents or compressed air.

To reduce the possibility of causing an electrical arc, which could result in a battery explosion, turn off all electrical loads from the battery before removing battery wires.



Wrap wrenches with vinyl tape to reduce the possibility of a dropped wrench 'shorting out' a battery, which could result in an explosion.

Reduce the possibility of accidental starting by removing and grounding spark plug wires and disconnecting battery at negative terminal before servicing.

The electrolyte in a battery is an acid solution which can cause severe burns to the skin and eyes. Treat all electrolyte spills to the body and eyes with extended flushing with clear water. Contact a physician immediately.

Any electrolyte spills should be neutralized with a solution of 2 teaspoons (10 ml) sodium bicarbonate (baking soda) dissolved in 1 quart (1 liters) of water and flushed with water.

Aerosol containers of battery terminal protectant must be used with extreme care. Insulate metal container to reduce the possibility of can contacting battery terminals which could result in an explosion.

It is in the best interest of both vehicle owner and service technician, to carefully follow the procedures recommended in this manual. Preventative maintenance, applied at recommended intervals, is the best guarantee for keeping the vehicle both dependable and economical.

This vehicle will give years of satisfactory service, providing it receives regular maintenance. Refer to the Periodic Service Schedule for appropriate service intervals (Ref Fig. 20 on page 18). Refer to Lubrication Points for appropriate lubrication locations (Ref Fig. 37 on page 27).

OPERATION AND SERVICE INFORMATION

Read all of Manual to become thoroughly familiar with this vehicle. Pay particular attention to all Notes, Cautions and Warnings



CAUTION

To prolong vehicle life, some maintenance items must be serviced more frequently on vehicles used under severe driving conditions such as extreme temperatures, extreme dust/debris conditions, frequent use with maximum load.

To access powertrain for routine maintenance, lift or remove seat. For major repair, refer to appropriate Technician's Repair and Service Manual.

Some service procedures may require the vehicle to be lifted. Refer to LIFTING THE VEHICLE for proper lifting procedure and safety information.

SERIAL NUMBER PLATE LOCATION

The serial number, manufacture date code label and supplemental information labels are on the vehicle. One is placed on the body below the front, driver side of the seat. The serial number, manufacture date code label and supplemental information labels located on the chassis under the seat.

Design changes take place on an ongoing basis. In order to obtain correct components for the vehicle, the manufacture date code, serial number and vehicle model must be provided when ordering service parts. The serial number is permanently etched on the frame.

Design changes take place on an ongoing basis. In order to obtain correct components for the vehicle, the manufacture date code, serial number and vehicle model must be provided when ordering service parts.

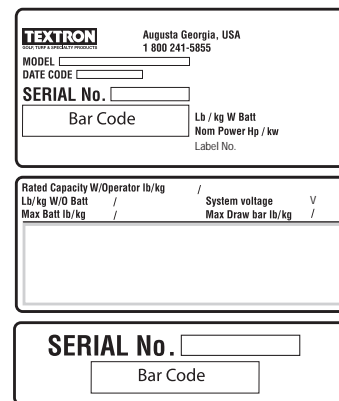
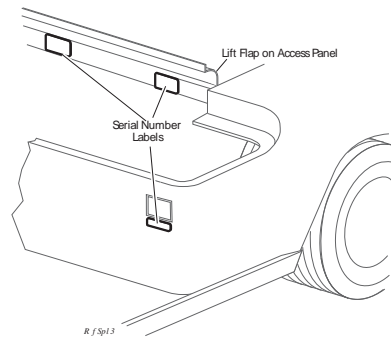

Fig. 19 Serial Number Plate Location

OPERATION AND SERVICE INFORMATION

Read all of Manual to become thoroughly familiar with this vehicle. Pay particular attention to all Notes, Cautions and Warnings

PERIODIC SERVICE SCHEDULE

✓ Check ♦ Clean, Adjust, etc. ▲ Replace	
To perform service that is listed in this schedule but not described in this manual, contact a local Service Representative or see the Repair and Service Manual for this vehicle.	
NOTE: Some maintenance items must be serviced more frequently on vehicles used under severe driving conditions	
DAILY	
	BEFORE USE: ✓ Check service brake general operation ✓ Check park brake operation - does it hold on a hill. ✓ Check warning device function in reverse ✓ Check tire pressure, condition of tires & rims. ✓ Check smooth operation of accelerator. ✓ Check for loose or missing hardware. ✓ Check Battery - state of charge, condition, loose terminals, corrosion, hold down & hardware ✓ Check overall vehicle condition
WEEKLY (includes items listed in previous table & the following)	
TIRES	✓ Examine for cuts, excessive wear and pressure (See GENERAL SPECIFICATIONS)
WHEELS	✓ Check for bent rims, missing or loose lug nuts
COOLING FAN	✓ Check for build-up of foreign matter inside blower housing and fins, clean if required
ENGINE OIL	✓ Check and add if required - DO NOT OVERFILL
STARTER/GENERATOR BELT	✓ Check for tension, wear, cracks
MONTHLY - 20 HOURS (includes items listed in previous table & the following)	
WIRING	✓ Check all wiring for loose connections and broken/missing insulation
ACCELERATOR	✓ Check for smooth movement - DO NOT LUBRICATE CABLE
SERVICE BRAKE (MECHANICAL BRAKES)	✓ Conduct brake performance test
PARK BRAKE	✓ Check brake performance and adjust if required
CHOKE CABLE	✓ Check for smooth movement and adjustment - DO NOT LUBRICATE CABLE
CARBURETOR LINKAGE	✓ Check attachment, adjust as required
DIRECTION SELECTOR	✓ Check attachment, adjust as required
ENGINE	✓ Check for unusual noise, vibration, acceleration, oil leaks
COOLING FAN	✓ Check for build-up of foreign matter inside blower housing and fins, clean if required
STEERING ASSEMBLY	✓ Check for abnormal play, tightness of all hardware
TIE ROD/LINKAGES	✓ Check for excessive play, bent components or loose connections
REAR AXLE	✓ Check for leakage, add SAE 30 oil as required
QUARTERLY - 60 HOURS (includes items listed in previous tables & the following)	
FRONT AXLE	✓ Check for damage to axle and loose or missing hardware
FRONT SHOCK ABSORBERS	✓ Check for oil leakage and loose fasteners
FRONT SPRINGS	✓ Check for loose hardware, cracks at attachments
FRONT WHEEL ALIGNMENT	✓ Check for unusual tire wear, align if required

Fig. 20 Periodic Service Schedule

OPERATION AND SERVICE INFORMATION

Read all of Manual to become thoroughly familiar with this vehicle. Pay particular attention to all Notes, Cautions and Warnings

PARK BRAKE	<ul style="list-style-type: none"> ✓ Check for bent/binding linkage rod ✓ Check for damage or wear to latch arm or catch bracket ◆ Lubricate as required, use light oil. DO NOT LUBRICATE CABLES OR BRAKE LATCH
REAR SHOCK ABSORBERS	✓ Check for oil leakage, loose mounting hardware
ENGINE ELECTRICAL SYSTEM	✓ Check coil/spark plug wires for cracks/loose connections
FUEL SYSTEM	<ul style="list-style-type: none"> ✓ Check for leaks at tank, cap, system lines, filters, pump, carburetor ✓ Check system lines for cracks/deterioration
THROTTLE/GOVERNOR LINKAGE	✓ Check operation and governed speed
HARDWARE AND FASTENERS	<ul style="list-style-type: none"> ✓ Check for loose or missing hardware and components ◆ Tighten or replace missing hardware
SEMI-ANNUAL - 125 HOURS (includes items listed in previous tables & the following)	
BATTERY	◆ Clean battery & terminals
DIRECTION SELECTOR	✓ Check for wear and smooth movement (lubricate shaft with light oil if required)
KING PINS	✓ Check for excessive play and tightness of retaining nuts
STEERING ASSEMBLY	✓ Check bellows and pinion seal for damage or grease leakage
RACK END BALL JOINT	◆ Lubricate, use wheel bearing grease
REAR AXLE	✓ Check for unusual noise and loose or missing mounting hardware
AIR FILTER ELEMENT	✓ Check filter element, clean/replace as required
OIL FILTER	▲ Replace (at oil change)
ENGINE OIL	▲ Replace with SAE 10W-30 or 10W-40 that meets or exceeds SF, SG, CC oil, DO NOT OVERFILL
DRIVE BELT	✓ Check for cracks, fraying and excessive wear
ANNUAL - 250-300 HOURS (includes items listed in previous tables & the following)	
FRONT WHEEL BEARINGS	✓ Check and adjust as required, see Technician's Repair and Service Manual
REAR AXLE	✓ Check lubricant, add lubricant (Ref Fig. 39 on page 28) as required
SERVICE BRAKES	<ul style="list-style-type: none"> ◆ Clean and adjust, see Technician's Repair and Service Manual ✓ Check brake shoe linings, see Technician's Repair and Service Manual ✓ Check level, add if required (DOT 3) and check for leakage
FUEL FILTER	▲ Replace
SPARK PLUG	▲ Replace, gap new plug (Ref Fig. 39 on page 28)
MUFFLER/EXHAUST	✓ Check mounting hardware; check for leaks at head and muffler gaskets
VALVES	✓ Check cold (intake/exhaust) per Technician's Repair and Service Manual
500 HOURS (includes items listed in previous tables & the following)	
CARBURETOR	◆ Clean
CYLINDER HEAD AND PISTON	<ul style="list-style-type: none"> ◆ Remove carbon from cylinder head and pistons ✓ Check valve seats for carbon buildup and clean as required

Fig. 20 Periodic Service Schedule

TIRE INSPECTION

Tire condition should be inspected per the Periodic Service Schedule (Ref. Fig. 20 on page 18). Inflation pressures should be checked when the tires are cool. Be sure to install the valve dust cap after checking or inflating.

OPERATION AND SERVICE INFORMATION

Read all of Manual to become thoroughly familiar with this vehicle. Pay particular attention to all Notes, Cautions and Warnings

FOUR CYCLE ENGINE

Engine Specifications

Engine model	FJ400D
Type.....	Four cycle, OHV
Number of cylinders	1
Displacement.....	401 cc
Rated horsepower	13 hp
Spark plug type.....	NGK BPR2ES
Spark plug gap028" - .031" (.70 - .80 mm)
Cooling	Forced air cooled
Oil Filter	Cartridge type full flow filter
Oil Pump.....	Positive displacement pump

Engine Description

The engine is an air cooled, 4-stroke, OHV, single cylinder gasoline engine. It incorporates a pressure fed lubrication positive displacement oil pump with a cartridge type full flow oil filter and a counter rotating balance shaft.

CHECKING THE OIL LEVEL



Do not overfill engine. Too much oil may cause engine to smoke or spark plug fouling.

Do not overfill engine. Too much oil may cause smoking or allow oil to enter the air filter enclosure.

The oil should be checked with the engine warm. The vehicle should be on a level surface with the parking (PARK) brake engaged. Allow adequate time for oil to drain into the crankcase before checking.

Remove the dipstick and wipe off the entire area with a lint free cloth (Ref Fig. 21 on page 20).

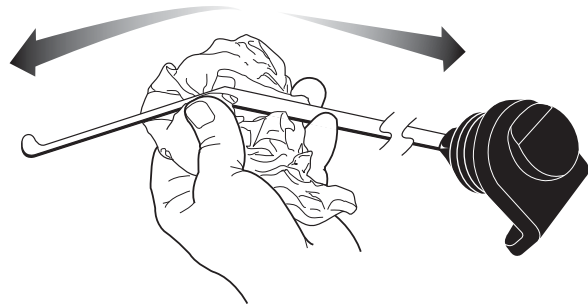

Fig. 21 Clean Entire Dipstick

Insert the dipstick **fully** into the dipstick hole and remove. Examine the level of the oil on the dipstick.

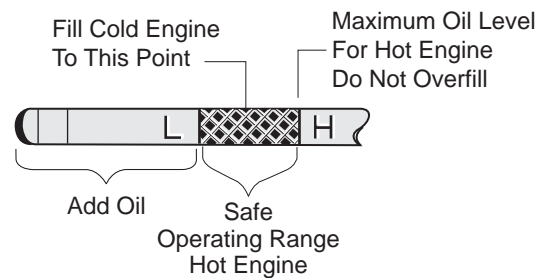

Fig. 22 Check Oil Level on Dipstick

The engine can be operated safely as long as oil is within the safe operating range as indicated on the dip stick. **Do not operate vehicle if oil level is below the safe area indicated on the dipstick.**

Oil should be added to bring the level into the safe operating range. Remember that oil expands as it gets hot, **Do not overfill** (Ref Fig. 22 on page 20). Check that the oil cap is firmly in place.

NOTE

When adding oil between oil changes, do not mix brands and viscosity grades of oil.

The oil dipstick/fill cap must be in place before operating the engine. Failure to install the dipstick/fill cap will result in oil becoming contaminated and/or oil being discharged into the engine compartment.

Changing the Oil

Tool List	Qty. Required
Socket, 3/8" drive.....	1
Ratchet, 3/8" drive	1

OPERATION AND SERVICE INFORMATION

Read all of Manual to become thoroughly familiar with this vehicle. Pay particular attention to all Notes, Cautions and Warnings

- Extension, 3/8" drive, 8" 1
- Oil drain pan..... 1
- Wrench 3/4" 1

For maximum performance and longevity, the engine oil should be replaced after the first 8 hours of operation. After the initial oil change, it should be changed every 125 hours of operation or semi-annually, whichever comes first.

The selection of oil is dependent upon the service that the vehicle will perform. Most vehicles require 10W-30 oil, whereas vehicles used at capacity or near capacity load applications will utilize 10W-40 oil after a break-in period of 100 hours (Ref Fig. 23 on page 21).

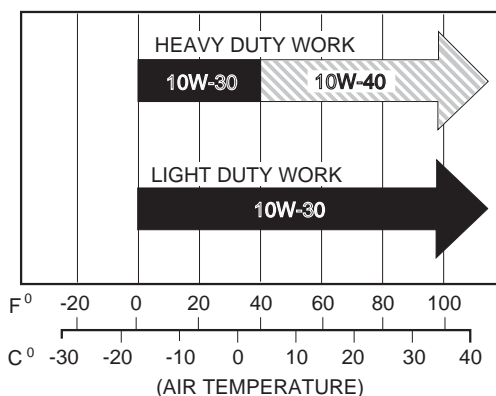

Fig. 23 Oil Viscosity Chart

NOTE

If vehicle is to be stored over winter months, it can be stored with old oil left in engine. The oil should be changed as part of spring maintenance. This will remove any moisture that has accumulated during storage.

WARNING

Be aware that engine fluids may be hot and contact to the skin may cause severe burns. Wear rubber gloves to protect skin from exposure to the old oil and degreaser.

The oil should be changed with engine warm. Park vehicle on a level surface, engage parking brake and remove key. Place a drain pan under engine. Wipe top of the engine clean with a cloth (Ref Fig. 24 on page 21). Remove the oil fill cap.

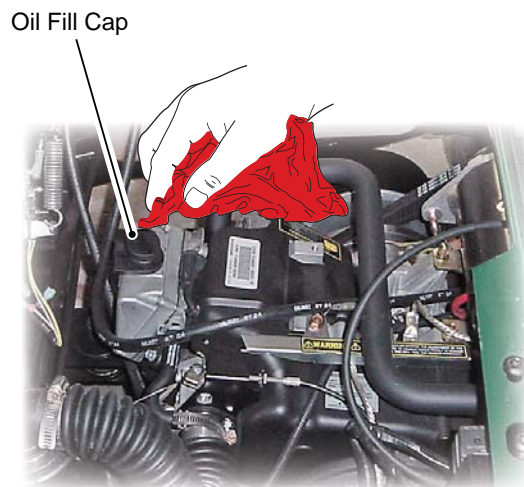

Fig. 24 Cleaning Top of Engine

Clean the area around filter. Using a filter wrench, strap wrench or other suitable wrench (A), remove the filter (B) from the engine and allow the oil to drain. The 'O' rings may remain on engine or filter (Ref Fig. 25 on page 21)

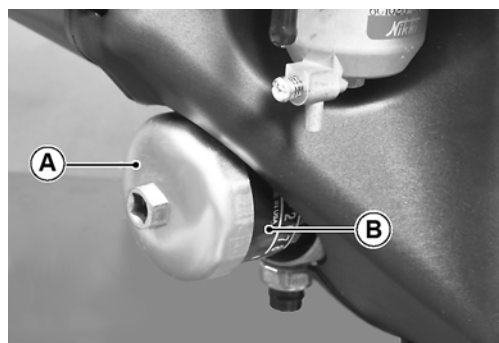

Fig. 25 Remove Oil Filter

Inspect the filter. Make sure the 'O' ring is not left on the engine surface.

OPERATION AND SERVICE INFORMATION

Read all of Manual to become thoroughly familiar with this vehicle. Pay particular attention to all Notes, Cautions and Warnings

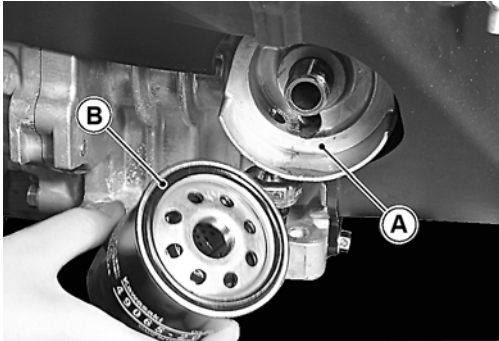

Fig. 26 Inspect Oil Filter

! WARNING

Be careful of hot oil when drained. It may be hot enough to burn you severely

Drain the oil by removing the drain plug found at the rear of the engine base. Remove using a 3/4" wrench. At the first oil change, **small** metal chips and lint may be found. This is normal, resulting from the break-in period. Inspect the filter at every oil change. The presence of large metal chips could indicate possible damage to the engine.

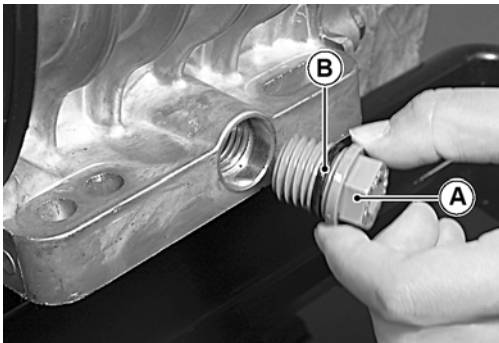

Fig. 27 Oil Drain Plug

Wipe the area around the drain plug mount with a lint free cloth and inspect the drain plug (A) for damage; replace if necessary. Replace the "O"-ring (B) with a new one and tighten to 61 in. lbs. (7.0 Nm) torque.

Apply engine oil to the oil filter seal and install oil filter onto the engine until the seal contacts mounting surface of the engine. Then turn the filter 2/3 to 3/4 rotations by HAND(S). Pour in the specified type and amount of oil See "Capacities and Replacement Parts" on page 28.

Oil capacity is 1 1/3 quarts (1.3 liters). Add slightly less than 1 1/3 quarts (1.3 liters) to allow for possible residual oil left in engine. The oil must be high quality oil that meets or exceeds API SF, SG, CC standards (Ref Fig. 28 on page 22). Check oil level on dipstick. Oil should be slightly below 'H' to allow for expansion. If necessary, continue to add oil slowly and allow time for oil to flow down into engine. Check oil level on dipstick. **Do not overfill.**

! CAUTION

Do not overfill engine. Too much oil may cause smoking or allow oil to enter the air filter enclosure.

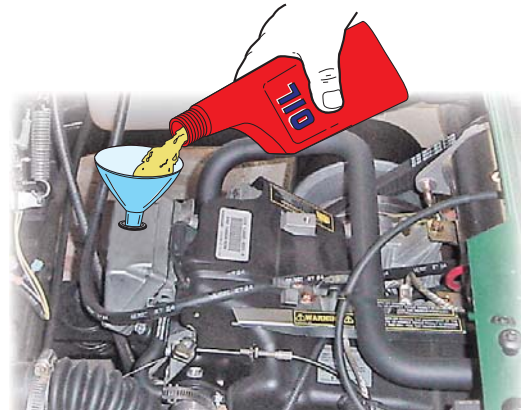

Fig. 28 Add Engine Oil

NOTE

Both the oil dipstick and fill cap must be in place before operating the engine. Failure to install the dipstick and fill cap will result in oil being discharged into the engine compartment.

As a final check, check the oil level again with the vehicle on level ground. Like all liquids, oil increases in volume when warm. The full 'H' mark on the dipstick is calibrated for an engine at operating temperature. When the engine is cold, the oil will be below the full mark. The engine can be operated safely as long as the oil is within the safe operating range as indicated on the dipstick. **Do not operate vehicle if oil level is below the safe area indicated on the dipstick.**

STARTER/GENERATOR BELT TENSION

Tool List	Qty. Required
Belt tension gauge.....	1
Wrench, 3/4".....	1
Wrench, 9/16".....	2

OPERATION AND SERVICE INFORMATION

Read all of Manual to become thoroughly familiar with this vehicle. Pay particular attention to all Notes, Cautions and Warnings

- Ratchet, 3/8" drive..... 1
- Socket, 3/4", 3/8" drive..... 1

The starter/generator belt tension should be checked after the first 15 - 20 hours and set to 75 - 80 lbs. (34 - 36 kg).

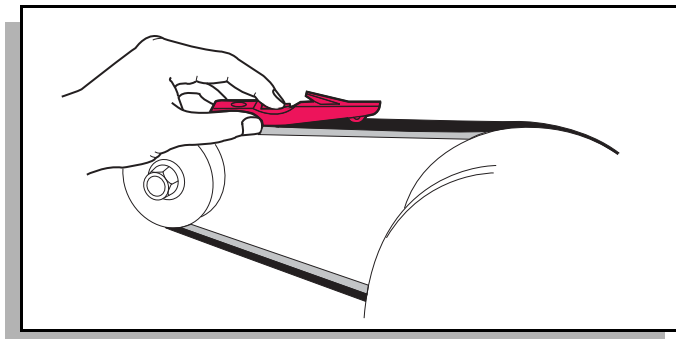

Fig. 29 Check Belt Tension with Gauge

NOTE

A loose belt can cause audible vibration and squeal.

Tighten a **new** starter/generator belt to 90 - 110 lbs. (41-50 kg) tension when a gauge is applied half way between the two pulleys (Ref Fig. 29 on page 23).

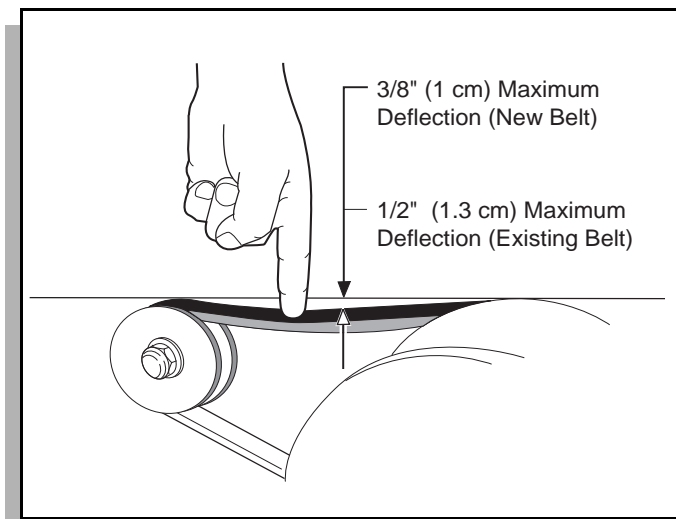

Fig. 30 Check Belt Tension Manually

A **new** belt may be checked manually. A maximum deflection of 3/8" (10 mm) is acceptable (Ref Fig. 30 on page 23). Tighten an **existing** belt to 75 - 80 lbs. (34 - 36 kg) tension using the same technique and inspect for cracking or wear. A maximum deflection of 1/2" (13 mm) is acceptable

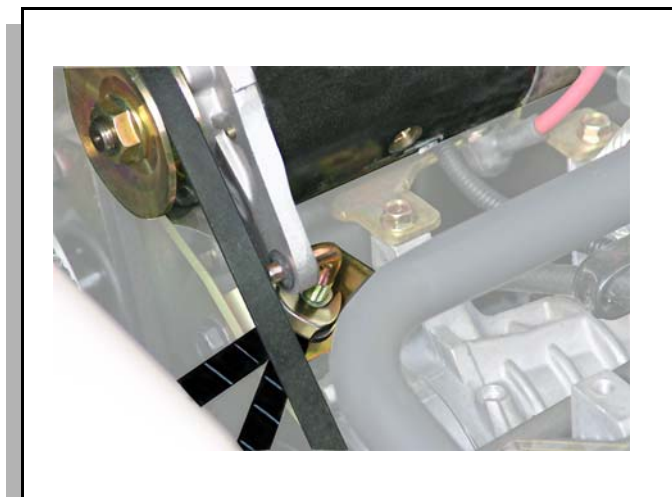

Fig. 31 Adjust Belt Tension

Adjusting The Belt

Loosen the starter/generator pivot bolt.

While holding the lower adjusting nut with a wrench, loosen the upper jam nut with another wrench. Move the lower nut up or down the adjustment bolt until proper belt tension is achieved. Hold the lower nut in place and tighten the upper jam nut against it (Ref Fig. 31 on page 23).

Tighten the starter/generator pivot bolt.

BATTERY CLEANING

CAUTION

To reduce the possibility of damage to vehicle or floor, neutralize acid before rinsing battery.

To reduce the possibility of damage to electrical components while cleaning, do not use a pressure washer.

Cleaning should take place per the Periodic Service Schedule (Ref. Periodic Service Schedule on page 18).

When cleaning the outside of the battery and terminals, first spray with a solution of sodium bicarbonate (baking soda) and water to neutralize any acid deposits before rinsing with clear water.

Use of a water hose without first neutralizing any acid, will move acid from the top of the battery to another area of the vehicle or storage facility where it will attack the metal structure or the concrete/asphalt floor. Additionally,

OPERATION AND SERVICE INFORMATION

Read all of Manual to become thoroughly familiar with this vehicle. Pay particular attention to all Notes, Cautions and Warnings

a residue will be left on the battery which is conductive and will contribute to the discharge of the battery.

⚠ WARNING

To reduce the possibility of battery explosion that could result in severe injury or death, do not use metallic spray wand to clean battery and keep all smoking materials, open flame or sparks away from the battery.

The correct cleaning technique is to spray the top and sides of the battery with a solution of sodium bicarbonate (baking soda) and water. This solution is best applied with a garden type sprayer equipped with a **non metallic spray wand or a plastic spray bottle**. The solution should consist of the amounts of sodium bicarbonate (baking soda) and clear water shown below (Ref Fig. 32 on page 24). In addition to the battery, special attention should be paid to metal components adjacent to the battery which should also be sprayed with the sodium bicarbonate (baking soda) solution.

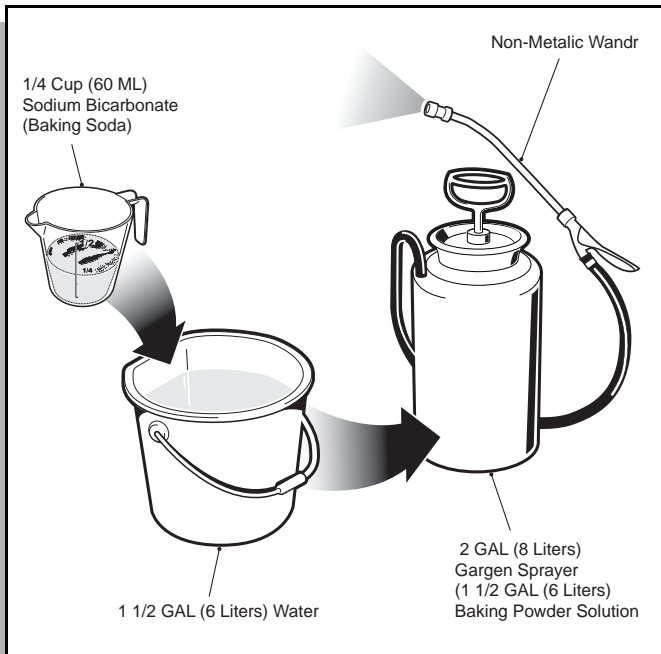

Fig. 32 Preparing Acid Neutralizing Solution

Allow the solution to sit for at least three minutes; use a soft bristle brush or cloth to wipe the tops of the battery to

remove any residue that could contribute to the self discharge of the battery. Rinse the entire area with low pressure clear water. Do not use a pressure washer.

BRAKES

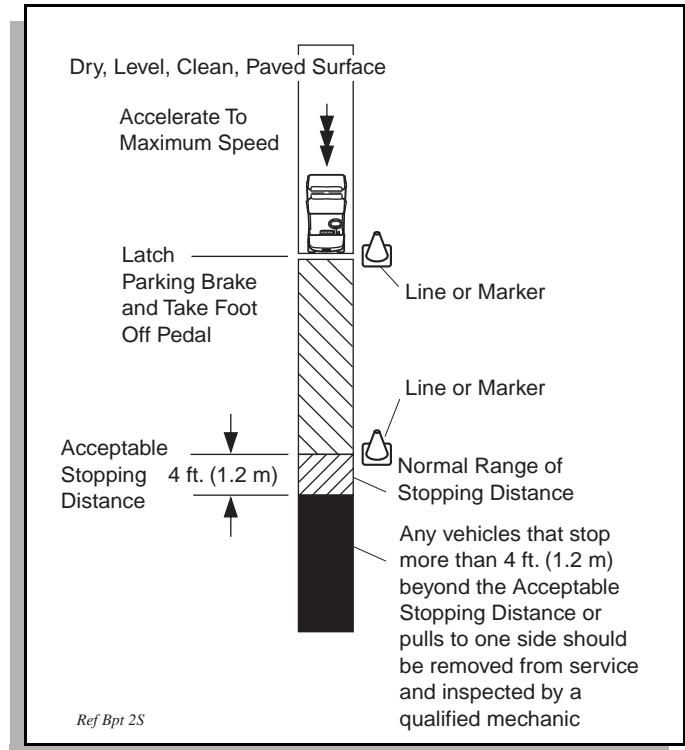

Fig. 33 Typical Brake Performance Test

⚠ WARNING

To reduce the possibility of severe injury or death, always evaluate pedal travel before operating a vehicle to verify some braking function is present.

All driving brake tests must be done in a safe location with regard for the safety of all personnel.

NOTE

Over time, a subtle loss of performance may take place; therefore, it is important to establish the standard with a new vehicle.

OPERATION AND SERVICE INFORMATION

Read all of Manual to become thoroughly familiar with this vehicle. Pay particular attention to all Notes, Cautions and Warnings

The Periodic Brake Performance Test should be performed regularly as an evaluation of braking system performance. It is useful as a method of identifying subtle loss of performance over time.

Periodic Brake Test For Mechanical Brakes

The purpose of this test is to compare the braking performance of the vehicle to the braking performance of new or 'known to be good' vehicles or to an established acceptable stopping distance. Actual stopping distances will be influenced by weather conditions, terrain, road surface condition, actual vehicle weight (accessories installed) and vehicle speed. No specific braking distance can be reliably specified. The test is conducted by latching the park brake to eliminate different pedal pressures and to include the affects of linkage mis-adjustment.

Establish the acceptable stopping distance by testing a new or 'known to be good' vehicle and recording the stopping location or stopping distance. For fleets of vehicles, several vehicles should be tested when new and the range of stopping locations or distances recorded.

NOTE

Over time, a subtle loss of performance may take place; therefore, it is important to establish the standard with a new vehicle.

Drive the vehicle at maximum speed on a flat, dry, clean, paved surface (Ref Fig. 33 on page 24). Quickly depress the brake pedal to latch the parking brake at the line or marker in the test area and remove foot from pedal. The vehicle should stop aggressively. The wheel brakes may or may not lock. Observe the vehicle stopping location or measure the vehicle stopping distance from the point at which the brakes were latched. The vehicle should stop within the 'normal' range of stopping distances. If the vehicle stops more than 4 ft. (1.2 m) beyond the acceptable stopping distance or pulls to one side, the vehicle has failed the test and should be tested again.

If the vehicle fails the second test, it should **immediately** be removed from service. The vehicle **must** be inspected by a qualified mechanic who should refer to the TROUBLESHOOTING section in the Technician's Repair and Service Manual.

AIR INTAKE AND COOLING FINS

WARNING

To prevent possible burns, engine parts should be kept clean to reduce risk of overheating and ignition of accumulated debris. After every off road use, allow to cool and then check for a build up of dirt and debris in the air intake and cooling fins. Dirt and debris may clog the engine's air cooling system. Clean areas shown to prevent engine damage. Keep linkages, springs and controls clean. Keep area around muffler free of any combustible material.

At least once a year, or more often under adverse conditions) the cooling system should be cleaned. Cleaning will assure an adequate supply of air to the cooling fins. Compressed air may be used for routine cooling system maintenance.

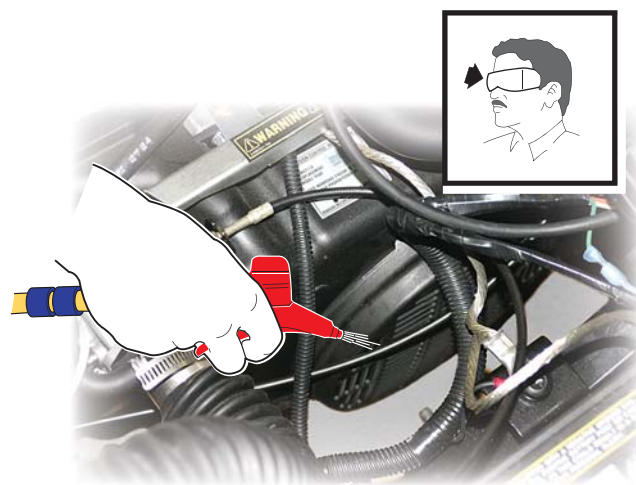

Fig. 34 Cleaning Cooling System with Air

REAR AXLE

The rear axle is provided with a lubricant level check plug located on the driver side at the rear of the housing (Ref Fig. 35 on page 26). Unless leakage of rear axle lubricant is evident, an annual lubricant check is sufficient.

Checking The Lubricant Level

Tool List	Qty. Required
Socket, 13 mm, 3/8" drive	1

OPERATION AND SERVICE INFORMATION

Read all of Manual to become thoroughly familiar with this vehicle. Pay particular attention to all Notes, Cautions and Warnings

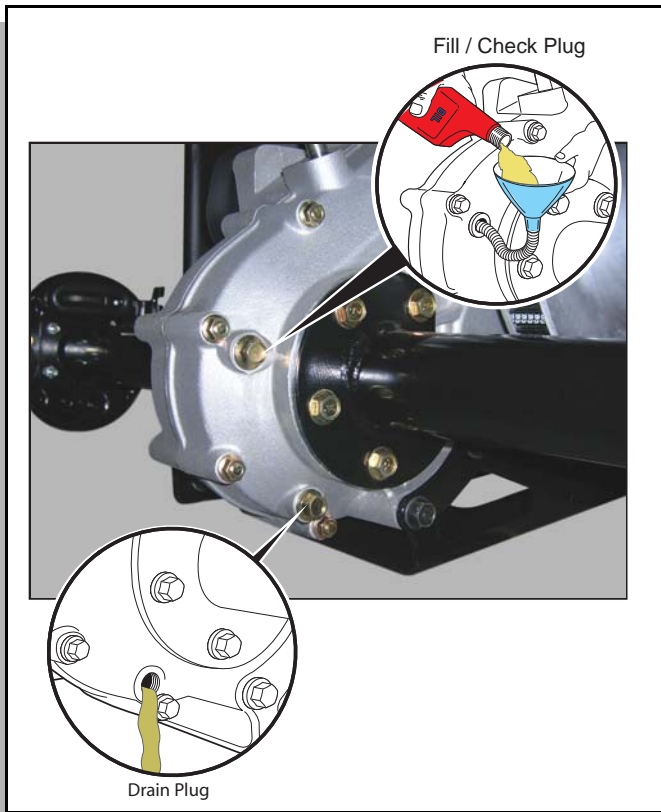

Fig. 35 Add, Check and Drain Rear Axle Lubricant

- Ratchet, 3/8" drive 1
- Funnel 1

Clean the area around the check and fill plugs. Remove the check plug. The correct lubricant level is **just** below the bottom of the threaded hole (Ref Fig. 35 on page 26). If lubricant is to be added, remove the fill plug and add lubricant slowly until lubricant starts to seep from the check plug hole. Install the check plug and the fill plug. In the event that the lubricant is to be replaced, a drain plug is provided at the bottom of the differential housing.

AIR CLEANER INSPECTION AND REPLACEMENT

The air cleaner unit on the vehicle is a dry unit. **Do not** use oil on the filter element or any part of the unit. To aide installation and sealing, petroleum jelly may be applied to back side of cover tabs and each side of filter seal.

Cleaning the Air Filter Element

CAUTION

Do not use compressed air to clean the air filter; doing so will damage the filter which may result in damage to the engine.

The air cleaner element is accessible by unsnapping the clips on the air canister and removing the cover and air filter element (Ref Fig. 36 on page 26). Clean inside of cover, canister and dust collector. Install the element and cover the same way they were removed. Be sure the positioning arrow on cover is pointing upward and all clips are fastened securely.

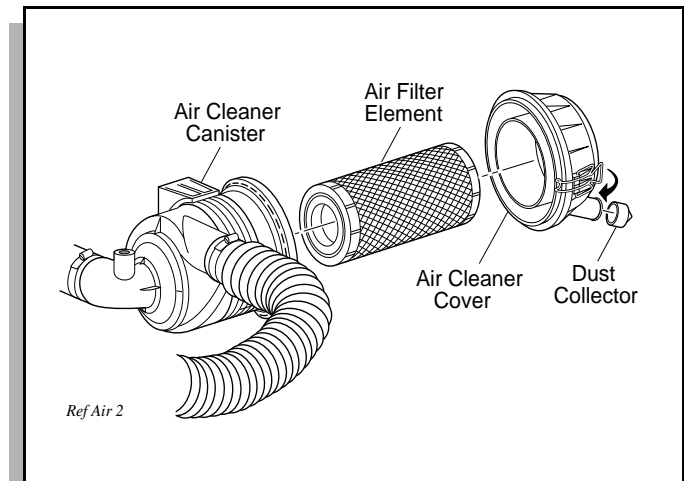

Fig. 36 Air Cleaner

If the element is in acceptable condition, loose dirt may be removed by tapping the filter lightly. Do not use oil on the filter element or any part of the unit.

LUBRICATION

CAUTION

Do not use more than three (3) pumps of grease in any grease fitting at any one time. Excess grease may cause grease seals to fail or grease migration into areas that could damage components.

Putting more than three pumps of grease in a grease fitting could damage grease seals and cause premature bearing failure (Ref Fig. 37 on page 27).

OPERATION AND SERVICE INFORMATION

Read all of Manual to become thoroughly familiar with this vehicle. Pay particular attention to all Notes, Cautions and Warnings

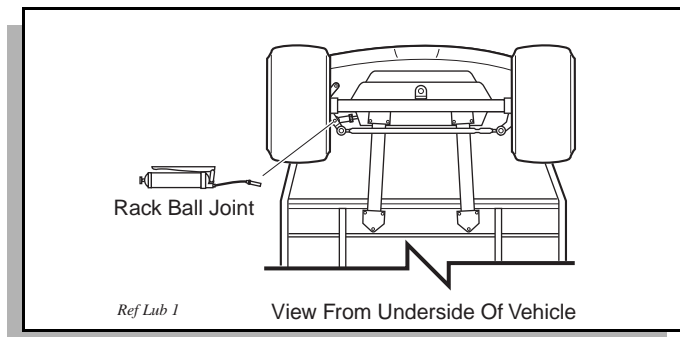

Fig. 37 Lubrication Points



CAUTION

SPARK PLUG

Tool List	Qty. Required
Spark plug socket, 13/16", 1/2" drive	1
Ratchet, 1/2" drive.....	1
Plug gauge, wire type	1
Anti-seize compound	AR
Torque wrench, 1/2" drive, ft. lbs.....	1

Use care not to over-tighten the plug. Over-tightening can cause damage to the aluminum cylinder head threads.

Remove and inspect the spark plug at intervals indicated in the Periodic Service Schedule (Ref Fig. 20 on page 18). The spark plug should be properly gapped (Ref Fig. 38 on page 27). Tighten to 16 ft. lbs. (22 Nm) torque.

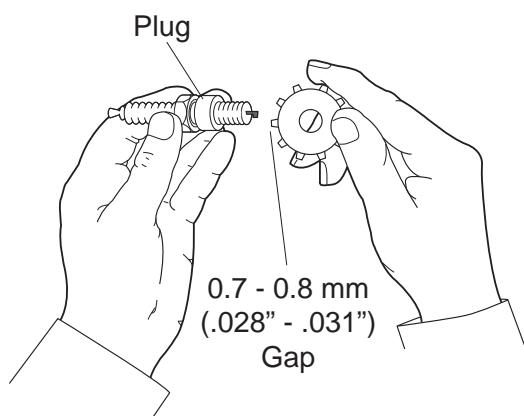

Fig. 38 Gapping the Spark Plug

Fouled spark plug is indicated by a wet, black appearance. This could be caused by a dirty air filter element or

other restrictions in the air intake system. Incorrectly adjusted valves, spark plug wire which are in poor condition or poor quality fuel could also contribute to the problem.

PROLONGED STORAGE



WARNING

To reduce the possibility of severe injury or death resulting from a possible explosion:

Do not handle fuel in an area that is not adequately ventilated. Do not smoke near the fuel tank or refuel near open flame or electrical items which could produce a spark.

Store vehicle in a clean, dry area. Do not store in same area as a stove, furnace, water heater, or other appliance that uses a pilot light or has a device that can create a spark.

When refueling, inspect the fuel cap for leaks or breaks that could result in fuel spillage.

Always wear safety glasses while refueling to prevent possible eye injury from gasoline or gasoline vapor.

Keep hands, clothing and jewelry away from moving parts. Use care not to contact hot objects. Raise the rear of the vehicle and support on jack stands before attempting to run the engine.

Preparing the engine for a prolonged storage period (30 days or more) calls for a few simple steps to prevent a build up of varnish and gum in the carburetor and corrosion in the engine.

- Raise the rear of the vehicle and support on jack stands. Refer to 'Lifting the Vehicle' for proper lifting procedure and safety information.
- Disconnect the fuel hose **at the fuel tank** and plug hose.
- With proper ventilation, depress the accelerator pedal and allow engine to run until it stops due to lack of fuel.
- Remove spark plug and pour about 1 oz. (30 ml) of engine oil into the cylinder. Replace spark plug,

OPERATION AND SERVICE INFORMATION

Read all of Manual to become thoroughly familiar with this vehicle. Pay particular attention to all Notes, Cautions and Warnings







ground spark plug wire and use starter to turn engine over a few seconds to distribute oil.

- Add a gasoline additive to the tank in accordance with the manufacturer's recommendations.
- Reattach fuel line to tank and drive the vehicle for several minutes to circulate the additive through the carburetor.
- While engine is still warm, change oil.
- Clean body, chassis and engine of debris, mud, chaff or grass.

Fuel Tank / Fuel	6.0 gal (22.5 liters) / 87 Octane Min.
Engine Oil	1.4 USqt (1.3 liters)
Oil Filter	P/N 26591-G01
Air Filter	P/N 28463-G01
Spark Plug	NGK BPR2ES (P/N 25523-G3) 020 - .030" (.71 - .75 mm) Gap
Starter/Generator Belt	P/N 606138
Clutch Belt	P/N 606136
Rear Axle Oil	51 oz (1.5 liters) / SAE 30
Fuse	15 amp (P/N 18392-G1)
Headlight Sealed Beam	(P/N 20209-G3)
Turn Signal Bulb	(P/N 20574-G3)
Tail Light Bulb	#1157 (P/N 21759-G1)

Fig. 39 Capacities and Replacement Parts

CAPACITIES AND REPLACEMENT PARTS

ALL TORQUE FIGURES ARE IN FT. LBS. (Nm)										
Unless otherwise noted in text, tighten all hardware in accordance with this chart.										
This chart specifies 'lubricated' torque figures. Fasteners that are plated or lubricated when installed are considered 'wet' and require approximately 80% of the torque required for 'dry' fasteners.										
BOLT SIZE	1/4"	5/16"	3/8"	7/16"	1/2"	9/16"	5/8"	3/4"	7/8"	1"
Grade 2 	4 (5)	8 (11)	15 (20)	24 (33)	35 (47)	55 (75)	75 (102)	130 (176)	125 (169)	190 (258)
Grade 5 	6 (8)	13 (18)	23 (31)	35 (47)	55 (75)	80 (108)	110 (149)	200 (271)	320 (434)	480 (651)
Grade 8 	6 (8)	18 (24)	35 (47)	55 (75)	80 (108)	110 (149)	170 (230)	280 (380)	460 (624)	680 (922)
BOLT SIZE	M4	M5	M6	M8	M10	M12	M14			
Class 5.8 (Grade 2) 	1 (2)	2 (3)	4 (6)	10 (14)	20 (27)	35 (47)	55 (76.4)			
Class 8.8 (Grade 5) 	2 (3)	4 (6)	7 (10)	18 (24)	35 (47)	61 (83)	97 (131)			
Class 10.9 (Grade 8) 	3 (4)	6 (8)	10 (14)	25 (34)	49 (66)	86 (117)	136 (184)			

Ref Tsp 1

Fig. 40 Torque Specifications and Bolt Grades

HARDWARE

OPERATION AND SERVICE INFORMATION

Read all of Manual to become thoroughly familiar with this vehicle. Pay particular attention to all Notes, Cautions and Warnings

NOTES:

A large grid of graph paper for taking notes, consisting of 20 columns and 30 rows of small squares.

GENERAL SPECIFICATIONS

GENERAL SPECIFICATIONS

REFRESHER® 1200

STANDARD EQUIPMENT:

WEIGHT (dry fuel tank)	1064 lbs (482 kg)
TIRES	Front - 18 x 8.50 x 8 (4 ply rated), 18 x 9.50 x 8 (6 ply rated)
TIRE PRESSURE	18 - 22 psi (124 - 152 kPa) *
LOAD CAPACITY	1200 lbs (544 kg) (including operator, passenger, cargo and accessories)
REFRESHMENT UNIT	500 lbs (227 kg)
LOAD CAPACITY	
GROUND CLEARANCE	4.5" (11.4 cm)
CHASSIS	Welded high yield strength tubular steel with powder coat paint
BODY & FINISH	Front: Flexible, impact resistant panels. Color coat/clear coat finish Rear: Lightweight, replaceable steel panels
SAFETY	Dash mounted key switch, reverse warning indicator, 'deadman' accelerator control, integral handgrip on hip restraints, manual forward/reverse selector, electric horn, poly carbonate windshield
LIGHTING PACKAGE	Dual halogen headlights, optional taillights, brake lights, turn signals
STEERING WHEEL	Dual handgrips
BRAKES	Dual rear wheel mechanical, self-adjusting drum brakes. Combination service / park brake with automatic parking brake release (accelerator kick-off). Optional hydraulic front disc brakes
FRONT SUSPENSION	Heavy duty leaf springs with hydraulic shock absorbers
REAR SUSPENSION	Heavy duty leaf springs with hydraulic shock absorbers
STEERING	Self-compensating single reduction rack and pinion
DASH PANEL	Scuff resistant with four drink holders, fuel gauge, low oil pressure indicator light
SEATING	Formed fabric backed vinyl covers over cushion foam. Seating for operator and one passenger
ENGINE	13 HP (rated), 401 cc Single Cylinder, Air Cooled, Overhead Valve Pressurized Lubrication with replaceable Oil Filter Internal Balance Shaft Solid State Ignition Replaceable Dry Cartridge Air Filter & Remote Intake Fixed Jet Bowl Carburetor, Pulse Fuel Pump
VALVE TRAIN	Overhead valve
LUBRICATION	Pressurized oil system
BALANCER	Internal counter-rotating balance shaft
IGNITION	Solid State
CARBURETOR	Fixed jet, remote pulse fuel pump
AIR CLEANER	Replaceable dry cartridge element
DRIVE TRAIN	Automatic, continuously variable transmission (CVT)
ELECTRICAL SYSTEM	External starter/generator, Solid State regulator, 12 volt maintenance free battery, 425 CCA, 60 minute reserve
TRANSAXLE	High efficiency differential with helical gears, 11.42:1 ratio, ground speed governor, forward and reverse with neutral detent
FUEL TANK	6 gal (23 L)
SPEED	16 mph ± .5 mph (26 kph ± .8 kph)
NOISE	Sound pressure; continuous A- weighted equal to or less than 76 dB(A)
VIBRATION, WBV	The highest RMS value of weighted acceleration is 1.79 m/s ²
VIBRATION, HAV	The highest RMS value of weighted acceleration is less than 2.5 m/s ² The uncertainty of measurement is .85 m/s ²

REFRESHER® 1200 - CARB

Same as REFRESHER 1200 Gasoline except for fuel system parts to meet California emissions standards. See Parts Manual for replacement parts.

* Do not use low inflation pressure tires on any E-Z-GO vehicle. Do not use any tire which has a recommended inflation pressure less than the inflation pressure recommended in Owner's Manual.

Specifications subject to change without notice

GENERAL SPECIFICATIONS

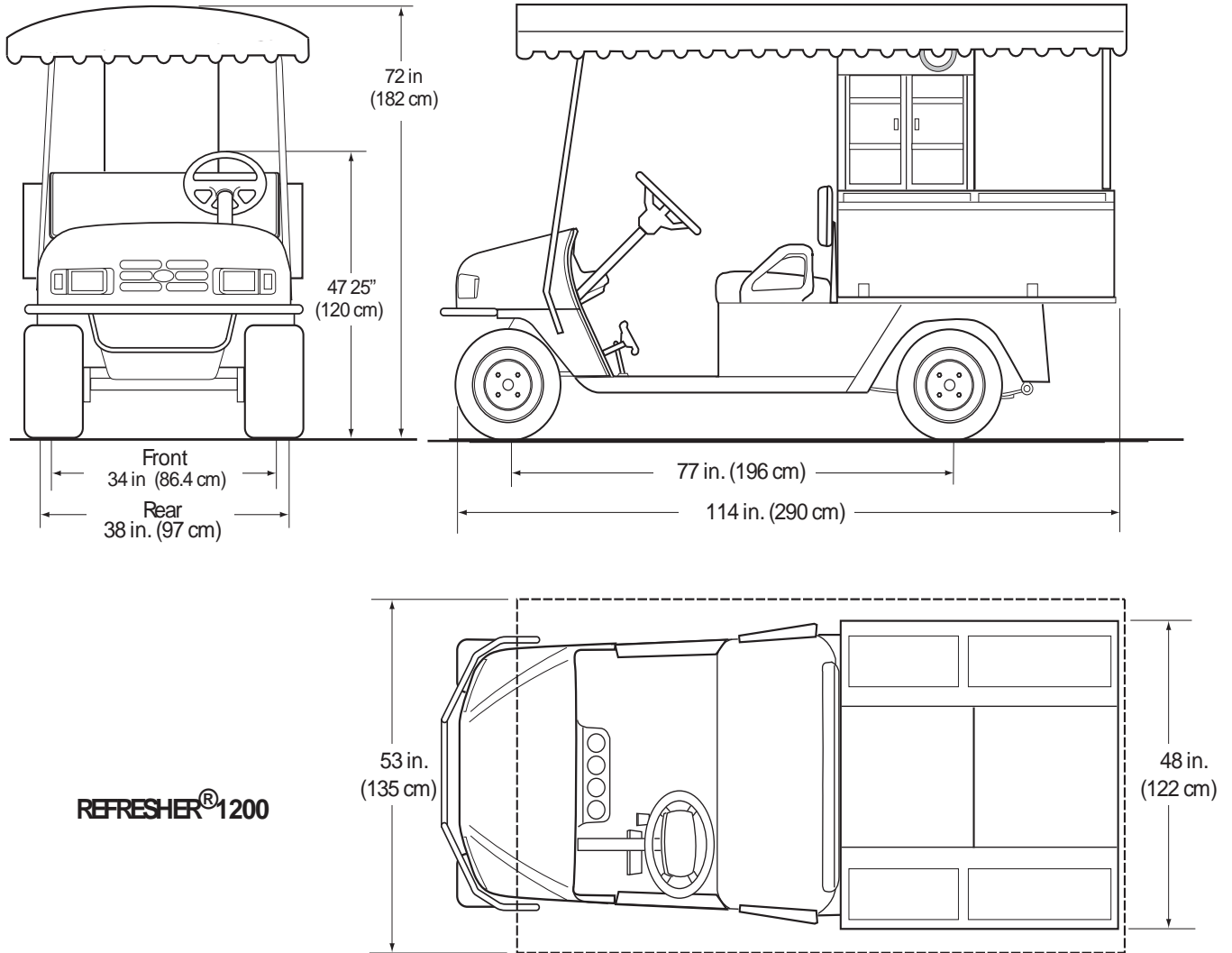

Fig. 41 Vehicle Dimensions

GENERAL SPECIFICATIONS

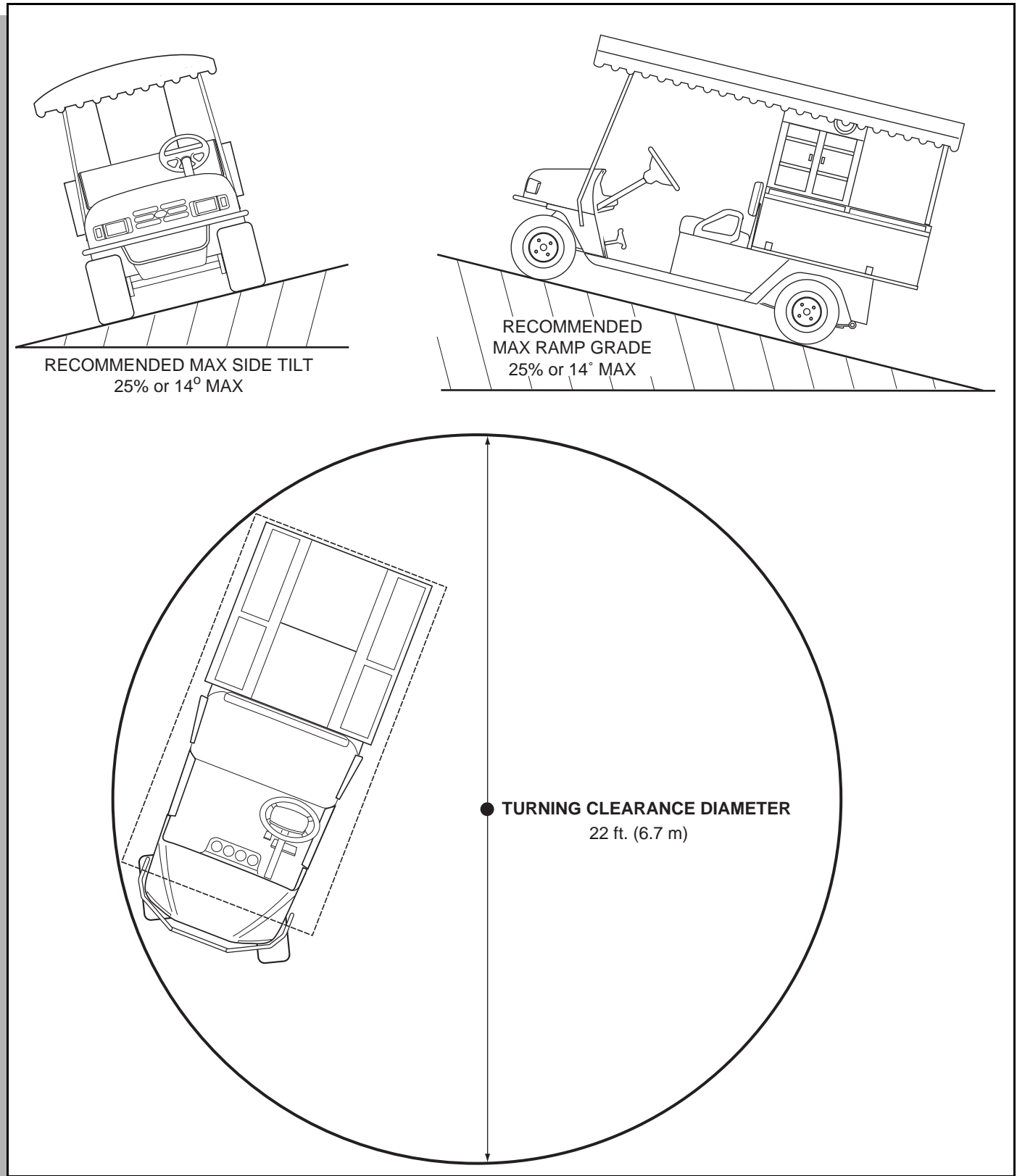

Fig. 42 Vehicle Dimensions, Incline Specifications and Turning Clearance Diameter

GENERAL SPECIFICATIONS

NOTES:

A large grid of graph paper for taking notes, consisting of 20 columns and 30 rows of small squares.

VEHICLE WARRANTIES

VEHICLE WARRANTIES

DOMESTIC WARRANTY (U.S. AND CANADA)

To obtain a copy of the limited warranty applicable to the vehicle, call or write a local Distributor, authorized Branch or the Warranty Department with vehicle serial number and manufacturer date code.

VEHICLE WARRANTIES - CALIFORNIA

CALIFORNIA EMISSION CONTROL WARRANTY STATEMENT YOUR WARRANTY RIGHTS AND OBLIGATIONS

The California Air Resources Board and E-Z-GO are pleased to explain the evaporative emission control system warranty on your 2010 vehicle. In California, new vehicles must be designed, built and equipped to meet the State's stringent anti-smog standards. E-Z-GO must warrant the EECS on your vehicle for the period of time listed below provided there has been no abuse, neglect or improper maintenance of your vehicle.

Your EECS may include parts such as the carburetor, fuel-injection system, the ignition system, catalytic converter, fuel tanks, fuel lines, fuel caps, valves, canisters, filters, vapor hoses, clamps, connectors, and other associated emission-related components.

Where a warrantable condition exists, E-Z-GO will repair your vehicle at no cost to you including diagnosis, parts and labor.

MANUFACTURER'S WARRANTY COVERAGE:

This evaporative emission control system is warranted for two years. If any evaporative emission-related part on your equipment is defective, the part will be repaired or replaced by E-Z-GO.

OWNER'S WARRANTY RESPONSIBILITIES:

As the vehicle owner, you are responsible for performance of the required maintenance listed in your owner's manual. E-Z-GO recommends that you retain all receipts covering maintenance on your vehicle, but E-Z-GO cannot deny warranty solely for the lack of receipts.

As the vehicle owner, you should however be aware that E-Z-GO may deny you warranty coverage if your vehicle or a part has failed due to abuse, neglect, or improper maintenance or unapproved modifications.

You are responsible for presenting your vehicle to E-Z-GO Division of Textron Inc. distribution center or service center as soon as the problem exists. The warranty repairs should be completed in a reasonable amount of time, not to exceed 30 days. If you have a question regarding your warranty coverage, you should contact your nearest authorized E-Z-GO service center or call the E-Z-GO Warranty Department at 1-800-448-7476

GENERAL EMISSIONS WARRANTY COVERAGE:

E-Z-GO warrants to the ultimate purchaser and each subsequent purchaser that the vehicle is:

Designed, built and equipped so as to conform with all applicable regulations; and

Free from defects in materials and workmanship that cause the failure of a warranted part to be identical in all material respects to that part as described in E-Z-GO's application for certification.

The warranty period begins on the date the vehicle is delivered to an ultimate purchaser or first placed into service. The warranty period is two years.

Subject to certain conditions and exclusions as stated below, the warranty on emission-related parts is as follows:

(1) Any warranted part that is not scheduled for replacement as required maintenance in the written instructions supplied, is warranted for the warranty period stated above. If the part fails during the period of warranty coverage, the part will be repaired or replaced by E-Z-GO according to subsection (4) below. Any such part repaired or replaced under warranty will be warranted for the remainder of the period.

(2) Any warranted part that is scheduled only for regular inspection in the written instructions supplied is warranted for the warranty period stated above. Any such part repaired or replaced under warranty will be warranted for the remaining warranty period.

VEHICLE WARRANTIES - CALIFORNIA

- (3) Any warranted part that is scheduled for replacement as required maintenance in the written instructions supplied is warranted for the period of time before the first scheduled replacement date for that part. If the part fails before the first scheduled replacement, the part will be repaired or replaced by ABC, Inc. according to subsection (4) below. Any such part repaired or replaced under warranty will be warranted for the remainder of the period prior to the first scheduled replacement point for the part.
- (4) Repair or replacement of any warranted part under the warranty provisions herein must be performed at a warranty station at no charge to the owner.
- (5) Notwithstanding the provisions herein, warranty services or repairs will be provided at all of our distribution centers that are franchised to service the subject engines or equipment.
- (6) The vehicle owner will not be charged for diagnostic labor that is directly associated with diagnosis of a defective, emission-related warranted part, provided that such diagnostic work is performed at a warranty station.
- (7) E-Z-GO is liable for damages to other engine or equipment components proximately caused by a failure under warranty of any warranted part.
- (8) Throughout the vehicle warranty period stated above, E-Z-GO will maintain a supply of warranted parts sufficient to meet the expected demand for such parts.
- (9) Any replacement part may be used in the performance of any warranty maintenance or repairs and must be provided without charge to the owner. Such use will not reduce the warranty obligations of E-Z-GO.
- (10) Add-on or modified parts that are not exempted by the Air Resources Board may not be used. The use of any non-exempted add-on or modified parts by the ultimate purchaser will be grounds for disallowing a warranty claims. E-Z-GO will not be liable to warrant failures of warranted parts caused by the use of a non-exempted add-on or modified part.

WARRANTED PARTS:

The repair or replacement of any warranted part otherwise eligible for warranty coverage may be excluded from such warranty coverage if E-Z-GO demonstrates that the vehicle has been abused, neglected, or improperly maintained, and that such abuse, neglect, or improper maintenance was the direct cause of the need for repair or replacement of the part. That notwithstanding, any adjustment of a component that has a factory installed, and properly operating, adjustment limiting device is still eligible for warranty coverage. The following emission warranty parts list are covered:

- (1) Fuel Tank
- (2) Fuel Cap
- (3) Fuel Line
- (4) Fuel Line Fittings
- (5) Clamps
- (6) Pressure Relief Valves
- (7) Control Valves
- (8) Control Solenoids
- (9) Electronic Controls
- (10) Vacuum Control Diaphragms
- (11) Control Cables
- (12) Control Linkages
- (13) Purge Valves
- (14) Vapor Hoses
- (15) Liquid/Vapor Separator
- (16) Carbon Canister
- (17) Canister Mounting Brackets
- (18) Carburetor Purge Port Connector

VEHICLE WARRANTIES - FEDERAL

FEDERAL EMISSIONS COMPONENT DEFECT WARRANTY

EMISSIONS COMPONENT DEFECT WARRANTY COVERAGE - This emission warranty is applicable in all States, except the State of California

Kawasaki Heavy Industries Ltd. and E-Z-GO Division of Textron Augusta, Georgia, (herein "E-Z-GO") warrant(s) to the initial retail purchaser and each subsequent owner, that this Non-road engine (herein "engine") has been designed, built, and equipped to conform at the time of initial sale to all applicable regulations of the U.S. Environmental Protection Agency (EPA), and that the engine is free of defects in materials and workmanship which would cause this engine to fail to conform with EPA regulations during its warranty period.

For the components listed under PARTS COVERED, the distributor, dealer, or service provider authorized by E-Z-GO will, at no cost to you, make the necessary diagnosis, repair, or replacement necessary to ensure that the engine complies with applicable U.S. EPA regulations.

EMISSION COMPONENT DEFECT WARRANTY PERIOD

The warranty period for this engine begins on the date of sale to the initial purchaser and continues for a period of 2 years.

PARTS COVERED

Listed below are the parts covered by the Emission Components Defect Warranty. Some of the parts listed below may require scheduled maintenance and are warranted up to the first scheduled replacement point for that part.

Fuel Metering System

Carburetor and internal parts (and/or pressure regulator or fuel injection system)

Air/fuel ratio feedback and control system, if applicable.

Cold start enrichment system, if applicable.

Air Induction System

Intake manifold, if applicable

Air filter.

Ignition System

Spark plugs.

Magneto or electronic ignition system.

Spark advance/retard system, if applicable.

Exhaust manifold, if applicable

Miscellaneous Items Used in Above Systems

Electronic controls, if applicable

Hoses, belts, connectors, and assemblies.

OBTAINING WARRANTY SERVICE

To obtain warranty service, take your engine to the nearest authorized E-Z-GO distributor, dealer, or service provider. Bring your sales receipts indicating date of purchase for this engine. The distributor, dealer, or service provider authorized by E-Z-GO will perform the necessary repairs or adjustments within a reasonable amount of time and furnish you with a copy of the repair order. All parts and accessories replaced under this warranty become the property of E-Z-GO.

WHAT IS NOT COVERED

Conditions resulting from tampering, misuse, improper adjustment (unless they were made by the distributor, dealer, or service provider authorized by E-Z-GO during a warranty repair), alteration, accident, failure to use the recommended fuel and oil, or not performing required maintenance services.

The replacement parts used for required maintenance services.

Consequential damages such as loss of time, inconvenience, loss of use of the engine or equipment, etc.

Diagnosis and inspection charges that do not result in warranty-eligible service being performed.

Any non-authorized replacement part, or malfunction of authorized parts due to use of non-authorized parts.

OWNER'S WARRANTY RESPONSIBILITIES

VEHICLE WARRANTIES - FEDERAL

As the engine owner, you are responsible for the performance of the required maintenance listed in your owner's manual. E-Z-GO recommends that you retain all receipts covering maintenance on your engine, but E-Z-GO cannot deny warranty solely for the lack of receipts or for your failure to ensure the performance of all scheduled maintenance.

As the engine owner, you should however be aware that E-Z-GO may deny warranty coverage if your engine or a part has failed due to abuse, neglect, improper maintenance or unapproved modifications.

You are responsible for presenting your engine to the nearest distributor, dealer, or service provider authorized by E-Z-GO when a problem exists.

If you have any questions regarding your warranty rights and responsibilities, you should contact the E-Z-GO Warranty Department at 1-800-241-5855 for the information.

THINGS YOU SHOULD KNOW ABOUT THE EMISSION CONTROL SYSTEM WARRANTY

MAINTENANCE AND REPAIRS

You are responsible for the proper maintenance of the engine. You should keep all receipts and maintenance records covering the performance of regular maintenance in the event questions arise. These receipts and maintenance records should be transferred to each subsequent owner of the engine. E-Z-GO reserves the right to deny warranty coverage if the engine has not been properly maintained. Warranty claims will not be denied, however, solely because of the lack of required maintenance or failure to keep maintenance records.

MAINTENANCE, REPLACEMENT OR REPAIR OF EMISSION CONTROL DEVICES AND SYSTEMS MAY BE PERFORMED BY ANY REPAIR ESTABLISHMENT OR INDIVIDUAL; HOWEVER, WARRANTY REPAIRS MUST BE PERFORMED BY A DISTRIBUTOR, DEALER OR, SERVICE PROVIDER AUTHORIZED BY E-Z-GO. THE USE OF PARTS THAT ARE NOT EQUIVALENT IN PERFORMANCE AND DURABILITY TO AUTHORIZED PARTS MAY IMPAIR THE EFFECTIVENESS OF THE EMISSION CONTROL SYSTEM AND MAY HAVE A BEARING ON THE OUTCOME OF A WARRANTY CLAIM.

If other than the parts authorized by E-Z-GO are used for maintenance replacements or for the repair of components affecting emission control, you should assure yourself that such parts are warranted by their manufacturer to be equivalent to the parts authorized by E-Z-GO in their performance and durability.

HOW TO MAKE A CLAIM

All repair qualifying under this limited warranty must be performed by a distributor, dealer, or service provider authorized by E-Z-GO. In the event that any emission-related part is found to be defective during the warranty period, you shall notify E-Z-GO Warranty Department at 1-800-241-5855 and you will be advised of the appropriate warranty service providers where the warranty repair can be performed.

**DECLARATION OF CONFORMITY
(EUROPE ONLY)**

DECLARATION OF CONFORMITY

**DECLARATION OF CONFORMITY • ДЕКЛАРАЦИЯ ЗА СЪОТВЕТСТВИЕ • PROHLÁŠENÍ O SHODĚ •
 OVERENSSTEMMELSESERKLÆRING • CONFORMITEITSVERKLARING • VASTAVUSDEKLARATSIOON •
 VAATIMUSTENMUKAISUUSVAKUUTUS • DECLARATION DE CONFORMITE • KONFORMITÄTSEKTLÄRUNG • ΔΗΛΩΣΗ
 ΣΥΜΜΟΡΦΩΣΗΣ • MEGFELELŐSÉGI NYILATKOZAT • DICHIARAZIONE DI CONFORMITÀ • ATBILSTĪBAS DEKLARĀCIJA •
 ATITIKTIES DEKLARACIJA • DIKJARAZZJONI TAL-KONFORMITÀ • DEKLARACJA ZGODNOŚCI • DECLARAÇÃO DE
 CONFORMIDADE • DECLARAȚIE DE CONFORMITATE • VYHLÁSENIE O ZHODE • IZJAVA O SKLADNOSTI • DECLARACIÓN
 DE CONFORMIDAD • DEKLARATION OM ÖVERENSSTÄMMELSE • SAMRÆMISYFIRLÝSING • KONFORMITETSERKLÆRING**

<p>Business name and full address of the manufacturer • Търговско име и пълен адрес на производителя • Obchodní jméno a plná adresa výrobce • Producentens firmanavn og fulde adresse • Bedrijfsnaam en volledige adres van de fabrikant • Toetja ärinimi ja täielik aadress • Valmistajan toimintimi ja täydellinen osoite • Nom commercial et adresse complète du fabricant • Firmenname und vollständige Adresse des Herstellers • Εταιρεία και ταχυδρομική διεύθυνση κατασκευαστή • A gyártó üzleti neve és teljes címe • Ragione sociale e indirizzo completo del fabbricante • Uz ŗēmuma nosaukums un pilna ražotāja adrese • Verslo pavadinimas ir pilnas gamintojo adresas • Isem kummetjali u indirizz shih tal-fabrikant • Nazwa firmy i pełny adres producenta • Nome da empresa e endereço completo do fabricante • Denumirea comercială și adresa completă a producătorului • Obchodný názov a úplná adresa výrobcu • Naziv podjetja in polni naslov proizvajalca • Nombre de la empresa y dirección completa del fabricante • Tillverkarens företagsnamn och kompletta adress • Fyrirt ækishielti og fullt heimilisfang framleiðanda • Fimanavn og full adresse for produsenten</p>	<p align="center">E-Z-GO Division of Textron Inc, 1451 Marvin Griffin Road Augusta, GA 30906 USA</p>
<p>Product Code • Код на продукта • Kód výrobku • Produktkód • Productcode • Toole kood • Tuotekoodi • Code produit • Produktcode • Κωδικός προϊόντος • Termékkód • Codice prodotto • Produkta kods • Produkto kodas • Kodíci tal-Prodott • Kod produktu • Código do Produto • Cod produs • Kód výrobku • Oznaka proizvoda • Código de producto • Produktkod • Vörunúmer • Produktkoda</p>	<p align="center">605787, 605784, 605812, 609279, 605813, 605814 When Fitted With CE Kit 614168</p>
<p>Machine Name • Наименование на машината • Název stroje • Maskinnavn • Machinenaam • Masina nimi • Laitteen nimi • Nom de la machine • Maschinenbezeichnung • Ονομασία μηχανήματος • Gêrnêr • Denominazione della macchina • Iek ārtas nosaukums • Mašinos pavadinimas • Isem tal-Magna • Nazwa urządzenia • Nome da Máquina • Numele echipamentului • Názov stroja • Naziv stroja • Nombre de la máquina • Maskinens namn • Helti t ækis • Maskinnavn</p>	<p align="center">E-Z-GO MPT, Cushman Commander and Jacobsen Hauler utility vehicle (gasoline models)</p>
<p>Designation • Предназначение • Oznáčení • Betegnelse • Benaming • Nimetus • Tuuypimerkintä • Pažymėjimas • Bezeichnung • Χαρακτηρισμός • Megnevezés • Funzione • Apzīmējums • Lietuanian • Denominazzjoni • Oznaczenie • Designação • Specificație • Oznaczenie • Namen stroja • Descripción • Bezeichnung • Merking • Konstruksjon</p>	<p align="center">Utility Vehicle</p>
<p>Serial Number • Серийн номер • Sériové číslo • Seriennummer • Seriennummer • Seerianumber • Valmistusnumero • Numéro de série • Seriennummer • Συριακός αριθμός • Sorozatszám • Numero di serie • Sērijas numurs • Serijs numurs • Numri Serjali • Numer serijny • Número de Série • Număr de serie • Sériové číslo • Serijska številka • Número de serie • Seriennummer • Račnúmer • Seriennummer</p>	<p align="center">2696143 to 2800000</p>
<p>Conforms to Directives • В съответствие с директивите • Splňuje podmínky směrnice • Er i overensstemmelse med direktiver • Voldoet aan de richtlijnen • Vastab direktividele • Direktyvnen mukalinen • Conforme aux directives • Entspricht Richtlinien • Ακολουθίστε πιστά τις Οδηγίες • Megfelel az irányelveknek • Conforme alle Direttive • Atbilst direktivām • Atitinka direktyvų reikalavimus • Valutazzjoni tal-Konformità • Dyrklyny zwięzane • Cumpré as Directivas • Respectă Directivele • Je v súlade so smernicami • Skladnost z direktivami • Cumple con las Directivas • Uppfyller direktiv • Samr æmist tilskipnumur • I samsvar med direktiv</p>	<p align="center">2006/42/EC</p>
<p>Conformity Assessment • Оценка за съответствие • Hodnocení plnění podmínek • Overensstemmelsesvurdering • Conformiteitsbeoordeling • Vastavusluokitus • Valmistusmukaisuuden arviointi • Evaluazione de conformitã • Konformitätsbeurteilung • Δελητιση Συμμορφωσης • Megfelelőségi értékelés • Valutazione della conformità • Atbilstības novērtējums • Atitikties iertinimas • Līvēli tal-Oawwa tal-Floss Imkajjal • Ocena zgodności • Avaliação de Conformidade • Evaluarea conformității • Vyhodnotenie zhodnosti • Ocena skladnosti • Evaluación de conformidad • Bedømming av överensstämelse • Samr æmismat • Konformitetsvurdering</p>	<p align="center">2006/42/EC Annex II</p>
<p>Harmonised standards used • Използвани хармонизирани стандарти • Použité harmonizované normy • Brugte harmoniserede standarder • Gebruikte geharmoniseerde standaards • Kasutatud ühustatud standardid • Käytetyt yhdenmukaistetut standardit • Normes harmonisées utilisées • Angewandte harmonisierte Normen • Εγκριση για τα πρότυπα που χρησιμοποιήθηκαν • Harmonizált szabványok • Standardi armonizzati applicati • Izmantoite saska ŗotie standarti • Panaudoti suderinti standartai • Standartas armonizati izati • Normy spóljne powiązane • Normes harmonizadas usadas • Standardele armonizate utilizate • Použité harmonizované normy • Uporabljeni usklajeni standardi • Estándares armonizados utilizados • Harmoniserade standarder som används</p>	<p align="center">EN 61000-6-2:2005 EN 61000-6-4:2007 EN ISO 5349:1986 EN ISO 11202</p>
<p>Technical standards and specifications used • Използвани технически стандарти и спецификации • Použité technické normy a specifikace • Brugte tekniske standarder og specifikationer • Gebruikte technische standaards en specificaties • Kasutatud tehnilised standardid ja spetsifikatsioonid • Käytetyt tekniset standardit ja eritelmat • Specificaciones et normes techniques utilisées • Angewandte technische Normen und Spezifikationen • Τεχνικά πρότυπα και προδιαγραφές που χρησιμοποιήθηκαν • Műszaki szabványok és specifikációk • Standard tecnici e specifiche applicati • Izmantoite tehniške standarti un specifikācijas • Panaudoti techniniai standartai ir techninė informacija • Standards u specifikazzjonijiet tekniki izati • Normy i specyfikacje techniczne powiązane • Normas técnicas e especificações usadas • Standardele tehnice și specificațiile utilizate • Použité technické normy a špecifikácie • Uporabljeni tehnični standardi in specifikacije • Estándares y especificaciones técnicas utilizadas • Tekniska standarder och specifikationer som används • Samr æmdir staðlar sem notaðir eru • Benyttede harmoniserede standarder</p>	<p align="center">ISO 2631-1:1985</p>
<p>The place and date of the declaration • Место и дата на декларацията • Místo a datum prohlášení • Sted og dato for erklæringen • Plaats en datum van de verklaring • Deklaratsiooni väljastamise koht ja kuupäev • Vakuutuksen paikka ja päivämäärä • Lieu et date de la déclaration • Ort und Datum der Erklärung • Τόπος και ημερομηνία δηλώσεως • A nyilatkozat kelte helye és idője • Luogo e data della dichiarazione • Deklarācijas vieta un datums • Deklarācijas vieta ir data • Il-post u d-data tad-dikjarazzjoni • Miejsce i data wystawienia deklaracji • Local e data de declaração • Local și data declarării • Miesto a datum vyhlášení • Kraj in datum izjave • Lugar y fecha de la declaración • Płats och datum för deklarationen • Tæknistaðlar og tæknifýsingar sem notaðir eru • Benyttede tekniske standarder og specifikationer • Sta ður og angsetning fyrifýsingar • Sted og dato for erklæringen</p>	<p align="center">E-Z-GO Division of Textron Inc, 1451 Marvin Griffin Road Augusta, GA 30906 USA</p>

DECLARATION OF CONFORMITY

Signature of the person empowered to draw up the declaration on behalf of the manufacturer, holds the technical documentation and is authorised to compile the technical file, and who is established in the Community.

Подпис на човека, упълномощен да състави декларацията от името на производителя, който поддържа техническата документация и е регистриран да изготви техническия файл и е регистриран в общността.

Podpis osoby oprávněné sestavit prohlášení jménem výrobce, držet technickou dokumentaci a osoby oprávněné sestavit technickou souboru a založen v rámci Evropského společenství.

Underskrift af personen, der har fuldmagt til at udarbejde erklæringen på vegne af producenten, der er indehaver af dokumentationen og er bemyndiget til at udarbejde den tekniske journal, og som er baseret i nærområdet.

Handtekening van de persoon die bevoegd is de verklaring namens de fabrikant te tekenen, de technische documentatie bewaart en bevoegd is om het technische bestand samen te stellen, en die is gevestigd in het Woongebied.

Uhenduse registreerise kantud isiku allkir, kes on volitatud tootja nimel deklaratsioon koostama, kes omab tehnilist dokumentatsiooni ja leiab on õigus koostada tehniline loomik.

Sen henkilöön allekirjoitus, jolla on valmistajan valtuutus vakautuksen laadintaan, jolla on hallussaan tekniset asiakirjat, joka on valtuutettu laatimaan tekniset asiakirjat ja joka on sijoittautunut yhteisöön.

Signature de la personne habilitée à rédiger la déclaration au nom du fabricant, à détenir la documentation technique, à compiler les fichiers techniques et qui est implantée dans la Communauté.

Unterschrift der Person, die berechtigt ist, die Erklärung im Namen des Herstellers abzugeben, die die technischen Unterlagen aufbewahrt und berechtigt ist, die technischen Unterlagen zusammenzustellen, und die in der Gemeinschaft niedergelassen ist.

Υπογραφή σπουδαστή εξουσιοδοτημένου για την σύνταξη της δήλωσης εκ μέρους του κατασκευαστή, ο οποίος κατέχει την τεχνική έκθεση και έχει την εξουσιοδότηση να τηρούνται τον τεχνικό φάκελο και ο οποίος είναι θεσπισμένος στην Κοινότητα.

A gyártó nevében meghatalmazott személy, akinek jogában áll módosítani a nyilatkozatot, a műszaki dokumentációt őrizi, engedélyvel rendelkezik a műszaki fájel összeállításához, és aki a közösségekben letelepedett személy.

Firma della persona autorizzata a redigere la dichiarazione a nome del fabbricante, in possesso della documentazione tecnica ed autorizzata a costituire il fascicolo tecnico, che deve essere stabilita nella Comunità.

Tās personas parakšs, kura ir pilnvarota deklarācijas sastādīšanai ražotāja vārdā, kuras ir tehniskā dokumentācija, kura ir pilnvarota sagatavot tehnisko reģistru un kura ir apstiprināta Kopienā.

Asmoo, kuris yra gana žinomas, kuriam gamintojas suteikė įgaliojimus sudaryti šią deklaraciją, ir kurie ją pasirašė, turi visą techninę informaciją ir yra įgaliojamas sudaryti techninės informacijos dokumentą.

Il-firma ta-persuna awtorizzata li fassal id-dikjarazzjoni f'isem il-fabbrikant, g' handha d-dokumentazzjoni teknika u hija awtorizzata li tkompla il-fajl tekniku u li hija stabbilita fl-Komunita.

Podpis osoby upowaznionej do sporzadzenia deklaracji w imieniu producenta, przechowujacej dokumentacje techniczna, upowazniona do stworzenia dokumentacji technicznej oraz wyznaczonej ds. wspolnotowych.

Assinatura da pessoa com poderes para emitir a declaracao em nome do fabricante, que possui a documentacao tecnica, que esta autorizada a compilar o processo tecnico e que esta estabelecida na Comunidade.

Semmltura personei imputernicite sa elaboreze declarajia in numele producatorului, care deține documentajia tehnică, este autorizată să compileze dosarul tehnic și este stabilită în Comunitate.

Podpis osoby poverenej vystavenim vyhlásenia v mene výrobcu, ktorá má technickú dokumentáciu a je oprávnená spracovať technické podklady a ktorá je umiestnená v Spoločenstve.

Podpis osebe, pooblašene za izdelavo izjave v imenu proizvajalca, ki ima tehnično dokumentacijo in lahko sestavlja spis tehnične dokumentacije, ter ima sedež v Skupnosti.

Firma de la persona responsabile de la declaración en nombre del fabricante, que posee la documentación técnica y está autorizada para recopilar el archivo técnico y que está establecido en la Comunidad.

Underteknas av den som bemyndigad att upprätta deklarationen åt tillverkarens vägnar, innehar den tekniska dokumentationen och är bemyndigad att sammanställa den tekniska informationen och som är etablerad i gemenskapen. Underskrift äollans sem hefur umboð til að gera yfirlýsinguna fyrir hönd framleiðandans, hefur undir höndum tæknigögnin og hefur leyfi til að taka saman tækniskýrsluna, og er viðurkandur innan evrópska efnahagssvæðisins.

Signaturen til personen som har fuldmagt til at udfærdige erklæringen på vegne af producenten, er i besiddelse af den tekniske dokumentationen, har autorisasjon til at udarbejde den tekniske filen og som har tilhold i EU.

2006/42/EC Annex II 1A: 2

Tim Lansdell

Technical Director

20th January 2010

Ransomes Jacobsen

Ltd, West Road, Ransomes Europark,
Ipswich,
England, IP3 9TT



2006/42/EC Annex II 1A: 10

Ronald L. Otten

Vice President of Engineering

E-Z-GO Division of Textron Inc,

1451 Marvin Griffin Road

Augusta, GA 30906 USA

20th January 2010

GB
United Kingdom

BG
Bulgaria

CH
Switzerland

CZ
Czech Republic

DK
Denmark

NL
Netherlands

EE
Estonia

ES
Spain

FI
Finland

FR
France

DE
Germany

GR
Greece

HU
Hungary

IS
Iceland

IT
Italy

LI
Liechtenstein

LV
Latvia

LT
Lithuania

MT
Malta

NO
Norway

PL
Poland

PT
Portugal

RO
Romania

SE
Sweden

SK
Slovakia

SI
Slovenia

DECLARATION OF CONFORMITY

NOTES:

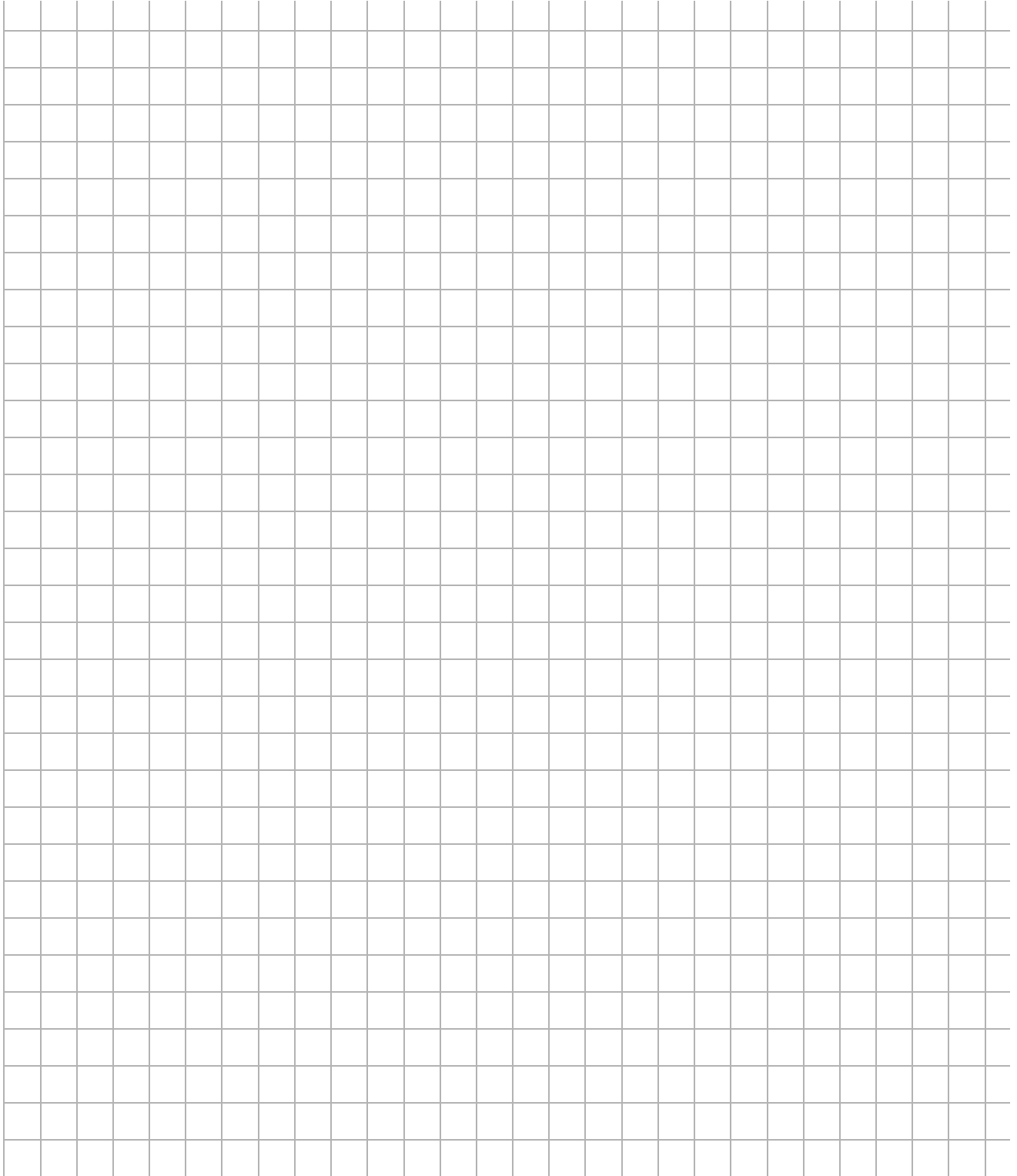
A large grid of graph paper for taking notes, consisting of 20 columns and 30 rows of small squares.

LABELS AND PICTOGRAMS

LABELS AND PICTOGRAMS

71131G01

71489G01

On Battery Under Seat

35493G01

28203G01

35962G01
35964G01

608862

AUTHORIZED REPRESENTATIVE IN EC IS:

RANSOMES JACOBSEN LTD.
WEST ROAD, IPSWICH,
SUFFOLK, IP3 9TT, UK

28203G01

27653G01

24880G01

74093G01

71419G01
71417G01
71415G01

LABELS AND PICTOGRAMS



WARNING

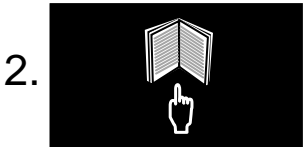

READ MANUAL



WARNING
USE CAUTION IN
INCLEMENT WEATHER



WARNING
DO NOT OPERATE
UNDER THE INFLUENCE
OF DRUGS OR ALCOHOL



MAXIMUM
CROSS HILL/RAMP
ANGLE AS SPECIFIED

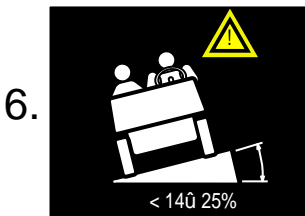

WARNING
MAXIMUM CROSS
HILL/RAMP ANGLE
AS SPECIFIED



LOAD WITH
HIGH CENTER
OF GRAVITY
COULD RESULT
IN TIP OVER



LOAD
CENTER
OF GRAVITY,
MAXIMUM
HEIGHT

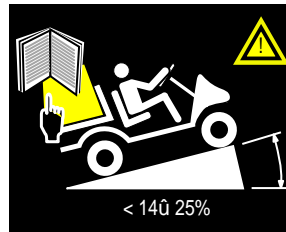

WARNING
READ MANUAL
FOR MAXIMUM
LOAD BED
CAPACITY.
MAXIMUM RAMP/HILL

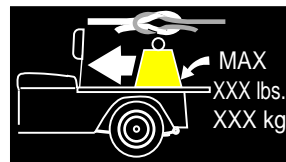

SECURE LOAD
AS FAR FORWARD
AS POSSIBLE.
MAXIMUM LOAD BED
CAPACITY



DO NOT RIDE IN
LOAD BED

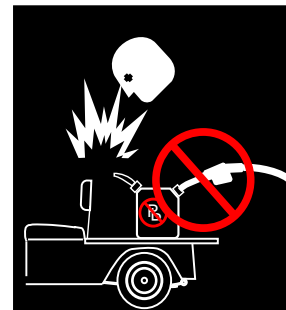

DANGER OF EXPLOSION
DO NOT FILL GAS CAN
IN LOAD BED

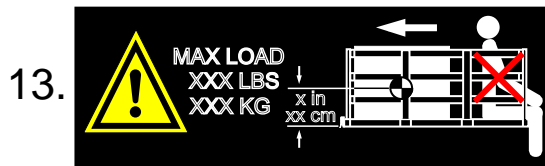



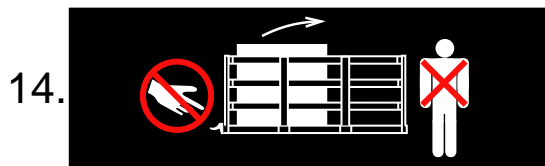









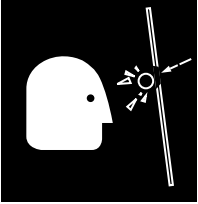





WARNING
MAXIMUM LOAD
& CENTER OF
GRAVITY.
KEEP LOAD
AS FAR
FORWARD AS
POSSIBLE.
DO NOT RIDE
IN LOAD BED

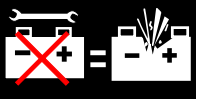
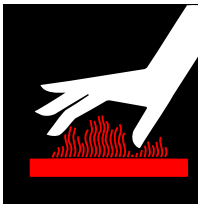









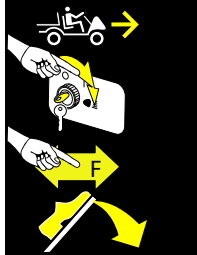
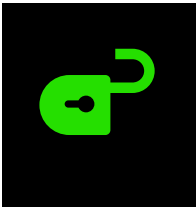
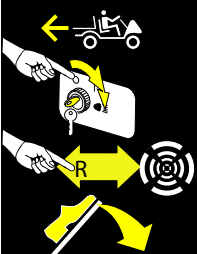

KEEP HANDS &
FINGERS AWAY
FROM DUMP BED.
DO NOT STAND
BEHIND DUMP
BED

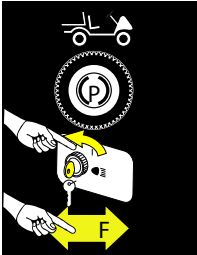
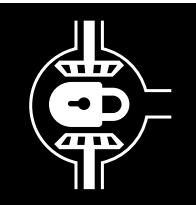
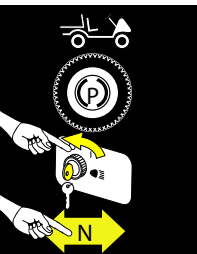
LABELS AND PICTOGRAMS

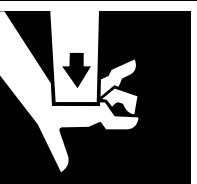
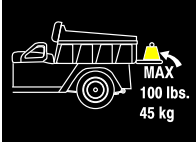
- | | | | | | |
|-----|---|--|-----|---|---|
| 15. |  | CLEAN UP GASOLINE SPILLS WITH WATER BEFORE STARTING ENGINE | 28. |  | DO NOT DISPOSE OF BATTERIES IN LANDFILL |
| 16. |  | UNLEADED GASOLINE | 29. |  | DO NOT DRIVE ON HIGHWAY |
| 17. |  | DO NOT SPILL FUEL ON A HOT ENGINE | 30. |  | WINDSHIELDS DO NOT PROVIDE PROTECTION FROM FLYING OBJECTS |
| 18. |  | GROUND FUEL PUMP | 31. |  | BATTERIES ARE HEAVY. USE CARE LIFTING |
| 19. |  | LOW OIL PRESSURE | 32. |  | USE INSULATED TOOLS |
| 20. |  | NEGATIVE GROUND BATTERY | 33. |  | WEAR EYE PROTECTION |
| 21. |  | DO NOT CONNECT POSITIVE BATTERY TERMINAL TO GROUND | 34. |  | NO SMOKING |
| 22. |  | SHORTING BATTERY TERMINALS MAY CAUSE EXPLOSION | 35. |  | HOT SURFACE |
| 23. |  | NO TAMPERING. KEEP HANDS OUT | 36. |  | OPERATE FROM DRIVERS SIDE ONLY |
| 24. |  | WARNING CORROSIVE | | | |
| 25. |  | WARNING EXPLOSIVE | | | |
| 26. |  | WARNING LETHAL VOLTAGE | | | |
| 27. |  | DO NOT EXPOSE TO FLAME | | | |

LABELS AND PICTOGRAMS

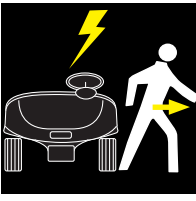
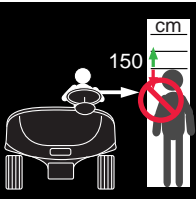
- | | | | | | |
|-----|---|---|-----|---|---|
| 37. |  | KEEP ARMS AND LEGS WITHIN VEHICLE | 45. |  | HEADLIGHTS |
| 38. |  | TO OPERATE VEHICLE IN FORWARD:
Q TURN KEY TO ON
Q MOVE DIRECTION SELECTOR TO FORWARD
Q DEPRESS ACCELERATOR PEDAL AND ACCELERATE SMOOTHLY | 46. |  | UNLOCKED |
| 39. |  | TO OPERATE VEHICLE IN REVERSE:
Q TURN KEY TO ON
Q MOVE DIRECTION SELECTOR TO REVERSE
Q AN AUDIBLE DEVICE WILL SOUND
Q DEPRESS ACCELERATOR PEDAL AND ACCELERATE SMOOTHLY | 47. |  | LOCKED |
| 40. |  | TO LEAVE A GASOLINE POWERED VEHICLE IN PARK:
Q APPLY PARKING BRAKE
Q TURN KEY TO OFF
Q MOVE DIRECTION SELECTOR TO FORWARD | 48. |  | DIFFERENTIAL LOCKED |
| 41. |  | TO LEAVE AN ELECTRIC POWERED VEHICLE IN PARK:
Q APPLY PARKING BRAKE
Q TURN KEY TO OFF
Q MOVE DIRECTION SELECTOR TO NEUTRAL | 49. |  | WARNING
KEEP ENTIRE BODY INSIDE CAR |
| 42. |  | KEEP CLEAR HAND OR FINGERS CAN BE TRAPPED | 50. |  | MAXIMUM TAILGATE LOAD |
| 43. |  | ON POSITION | 51. |  | ENGINE CRANKING POSITION |
| 44. |  | OFF POSITION | 52. |  | LEAVE VEHICLE WHEN LIGHTNING IS IN THE AREA |
| | | | 53. |  | MINIMUM HEIGHT TO OPERATE VEHICLE |

LABELS AND PICTOGRAMS

NOTE

Read and understand the following warnings before attempting to operate the vehicle:



WARNING

To prevent personal injury or death, observe the following:

When vehicle is to be left unattended, engage parking brake, move direction selector to 'F' (forward) position, turn key to 'OFF' position and remove key.

Drive vehicle only as fast as terrain and safety considerations allow. Consider the terrain and traffic conditions. Consider environmental factors which effect the terrain and the ability to control the vehicle.

Avoid driving fast down hill. Sudden stops or change of direction may result in a loss of control. Use service brake to control speed when traveling down an incline.

Use extra care and reduced speed when driving on poor surfaces, such as loose dirt, wet grass, gravel, etc.

All travel should be directly up or down hills.

Use extra care when driving the vehicle across an incline.

Stay in designated areas and avoid steep slopes. Use the parking brake whenever the vehicle is parked.

Keep feet, legs, hands and arms inside vehicle at all times.

Avoid extremely rough terrain.

Check area behind the vehicle before operating in reverse.

Make sure the direction selector is in correct position before attempting to start the vehicle.

Slow down before and during turns. All turns should be executed at reduced speed.

Always bring vehicle to a complete stop before shifting the direction selector.

See GENERAL SPECIFICATIONS for vehicle load and seating capacity.

NOTE

Read and understand the following text and warnings before attempting to service vehicle:

In any product, components will eventually fail to perform properly as the result of normal use, age, wear or abuse.

It is virtually impossible to anticipate all possible component failures or the manner in which each component may fail.

Be aware that a vehicle requiring repair indicates that the vehicle is no longer functioning as designed and therefore should be considered potentially hazardous. Use extreme

care when working on any vehicle. When diagnosing, removing or replacing any components that are not operating correctly, take time to consider the safety of yourself and others around you should the component move unexpectedly.

Some components are heavy, spring loaded, highly corrosive, explosive or may produce high amperage or reach high temperatures. Gasoline, carbon monoxide, battery acid and hydrogen gas could result in serious bodily injury to the technician/mechanic and bystanders if not treated with the utmost caution. Be careful not to place hands, face, feet or body in a location that could expose them to injury should an unforeseen situation occur.

Always use the appropriate tools listed in the tool list and wear approved safety equipment.



WARNING

Before working on the vehicle, remove all jewelry (rings, watches, necklaces, etc.)

Be sure that no loose clothing or hair can contact moving parts.

Use care not to touch hot objects.

Raise rear of vehicle and support on jack stands before attempting to run or adjust powertrain.

Wear eye protection when working on or around vehicle. In particular, use care when working around batteries, using solvents or compressed air.

Hydrogen gas is formed when charging batteries. Do not charge batteries without adequate ventilation.

Do not permit open flame or anyone to smoke in an area that is being used for charging batteries. A concentration of 4% hydrogen gas or more is explosive.

Engine exhaust gas (carbon monoxide) is deadly. Carbon monoxide is an odorless, colorless gas that is formed as a natural part of incomplete combustion of hydrocarbon fuels. Carbon monoxide is a dangerous gas that can cause unconsciousness and is potentially lethal.

The following are symptoms of carbon monoxide inhalation:

- Dizziness
- Vomiting
- Intense Headache
- Muscular Twitching
- Weakness and Sleepiness
- Throbbing in Temples

If any of these symptoms are experienced, get fresh air immediately. Never work around or operate a vehicle in an environment that does not ventilate exhaust gases from the area.



A Textron Company

E-Z-GO Division Of Textron, Inc.,
1451 Marvin Griffin Road, Augusta, Georgia USA 30906-3852

TO CONTACT US

North America:

Technical Assistance & Warranty Phone: 1-800-774-3946, FAX: 1-800-448-8124
Service Parts Phone: 1-888-GET-EZGO (1-888-438-3946), FAX: 1-800-752-6175

International:

Phone: 001-706-798-4311, FAX: 001-706-771-4609

Certified ISO 9001 / ISO 14001 by



Copyrighted Material
This manual may not be reproduced in whole or
in part without the express permission of
E-Z-GO Division of Textron, Inc.
Technical Communications Department